

User Guide

Trimble® DiNi® Digital Level

Version 2.0
Part Number 57345002
December 2007



Corporate Office

Trimble Navigation Limited
645 North Mary Avenue
PO Box 3642
Sunnyvale, CA 94085
USA

www.trimble.com

Trimble Navigation Limited
Geomatics and Engineering Division
5475 Kellenburger Road
Dayton, Ohio 45424-1099
USA

800-538-7800 (toll free in USA)
+1-937-245-5600 Phone
+1-937-233-9004 Fax
www.trimble.com

Copyright and Trademarks

© 2006-2007, Trimble Navigation Limited. All rights reserved. Trimble, the Globe & Triangle logo and DiNi are trademarks of Trimble Navigation Limited, registered in the United States Patent and Trademark Office and in other countries.

All other trademarks are the property of their respective owners.

This product is covered by the following patents: DE 3739664; DE 4419524; US 5572009 and US 5802206

Release Notice

This is the December 2007 release of the Trimble DiNi User Guide, part number 57345002, version 2.0

Product Warranty Information

For applicable product warranty information, please refer to the Warranty Card included with this Trimble product, or consult your Trimble dealer.

Notices

Europe

This product has been tested and found to comply with the requirements for a Class B device pursuant to European Council Directive 89/336/EEC on EMC, thereby satisfying the requirements for CE Marking and sale within the European Economic Area (EEA). These requirements are designed to provide reasonable protection against harmful interference when the equipment is operated in a residential or commercial environment.



Australia and New Zealand

This product conforms with the regulatory requirements of the Australian Communications Authority (ACA) EMC framework, thus satisfying the requirements for C-Tick Marking and sale within Australia and New Zealand.



Taiwan – Battery Recycling Requirements

The product contains a removable Lithium-ion battery. Taiwanese regulations require that waste batteries are recycled.



Notice to Our European Union Customers

For product recycling instructions and more information, please go to www.trimble.com/ev.shtml.

Recycling in Europe: To recycle Trimble WEEE (Waste Electrical and Electronic Equipment, products that run on electrical power.), Call +31 497 53 24 30, and ask for the "WEEE Associate". Or, mail a request for recycling instructions to:



Trimble Europe BV
c/o Menlo Worldwide Logistics
Meerheide 45
5521 DZ Eersel, NL

Important Information

Carefully read the manual before the first use. Be sure to comply with the safety information.

Safety Information

Instruments and original accessories from Trimble must only be used for the intended purpose.



-
- WARNING** – Operate the instrument only in compliance with the operating conditions specified.
- Do not point the telescope directly at the sun.
 - Do not use the instrument and accessories in rooms with danger of explosion.
 - When you work with staves in the vicinity of electric plants (e.g. electric railways, aerial lines, transmitting stations, etc.) your life is acutely endangered. This risk exists independent of the material (e.g. aluminium or wood). In such cases it is necessary to inform the competent and authorised safety authorities and observe their instructions.
 - Protect operator and instrument sufficiently at the site of measurement (e.g. construction site, roads, etc.). Observe any relevant national regulations and the Road Traffic Act.
 - Do not carry out surveying work in a thunderstorm to avoid being struck by a lightning.
-

Battery Safety



-
- WARNING** – Do not damage the rechargeable Lithium-ion battery. A damaged battery can cause an explosion or fire, and can result in personal injury and/or property damage. To prevent injury or damage:
- Do not use or charge the battery if it appears to be damaged. Signs of damage include, but are not limited to, discoloration, warping, and leaking battery fluid.
 - Do not expose the battery to fire, high temperature, or direct sunlight.
 - Do not immerse the battery in water.
 - Do not use or store the battery inside a vehicle during hot weather.
 - Do not drop or puncture the battery.
 - Do not open the battery or short-circuit its contacts.
-



-
- WARNING** – Avoid contact with the rechargeable Lithium-ion battery if it appears to be leaking. Battery fluid is corrosive, and contact with it can result in personal injury and/or property damage. To prevent injury or damage:
- If the battery leaks, avoid contact with the battery fluid.
 - If battery fluid gets into your eyes, immediately rinse your eyes with clean water and seek medical attention. Do not rub your eyes!
 - If battery fluid gets onto your skin or clothing, immediately use clean water to wash off the battery fluid.
-



WARNING – Charge and use the rechargeable Lithium-ion battery only in strict accordance with the instructions. Charging or using the battery in unauthorized equipment can cause an explosion or fire, and can result in personal injury and/or equipment damage. To prevent injury or damage:

- Do not charge or use the battery if it appears to be damaged or leaking.
 - Charge the Lithium-ion battery only in a Trimble product that is specified to charge it. Be sure to follow all instructions that are provided with the battery charger.
 - Discontinue charging a battery that gives off extreme heat or a burning odor.
 - Use the battery only in Trimble equipment that is specified to use it.
 - Use the battery only for its intended use and according to the instructions in the product documentation.
-

Environmental Information

NOTICE FOR TRIMBLE'S EUROPEAN UNION CUSTOMERS

Trimble is pleased to announce a new recycling program for our European Union customers. At Trimble, we recognize the importance of minimizing the environmental impacts of our products. We endeavor to meet your needs, not only when you purchase and use our products, but also when you are ready to dispose of them. That is why Trimble is actively pursuing, and will continue to pursue, the expanded use of environmentally friendly materials in all its products, and why we have established a convenient and environmentally friendly recycling program.

As Trimble makes additional recycling facilities available for your use, we will post their locations and contact information to our Recycling Instructions web page.

For product recycling instructions and more information, please go to

www.trimble.com/environment/summary.html

Recycling in Europe:

To recycle Trimble WEEE,

Call +31 497 53 2430, and ask for the “WEEE Associate”

Or

Mail a request for recycling instructions to:

Trimble Europe BV

c/o Menlo Worldwide Logistics

Meerheide 45

5521 DZ Eersel, NL



Equipment Information



CAUTION – Do not make any changes or repairs on the instrument and accessories. This must be done only by a service team or by authorised technical staff.

- Do not initialise the data memory without making a back up of the stored data, as the initialisation will delete all stored data.
 - Do tread tripod legs firmly into the ground to prevent sinking in and falling over of the instrument by wind pressure.
 - Do mount the instrument to the tripod using the tripod screw immediately after you take the instrument from its case.
 - Do not leave the instrument placed loosely on the tripod head. After loosening the tripod screw, immediately store the instrument in its case.
 - Do check your instrument at regular intervals in order to avoid faulty measurements, especially after it has been subjected to shock or heavy punishment.
 - Do not use the instrument too long when it is raining. During breaks, cover the instrument with the protective hood. Wipe the instrument and case dry in the field and let it dry completely indoors, with the case open.
 - Do remove the batteries in case of unloading or a longer time without using the instrument.
 - Do only recharge the batteries with the intended Trimble charger.
 - Do properly dispose of the batteries and equipment taking into account the applicable national regulations. Prevent improper use of the disposed instrument by proper disposal
 - Do verify before every use of the instrument, that it is in perfect condition, particularly after longer transportation, fall or any other improper use. Systematically check measurements particularly before and after extensive surveying projects will help to avoid erroneous measurements.
 - Do not use destroyed plugs and cables for accessories with the instrument
-

Declaration of Conformity

Trimble DiNi



EG-Konformitätserklärung EC Declaration of Conformity

TRIMBLE JENA GMBH • 07745 Jena • Germany
(Qualitätsmanagementsystem zertifiziert nach/Quality Management System certified to meet:
DIN EN ISO 9001:2000)

Wir erklären hiermit die Übereinstimmung des genannten Gerätes mit der EG-Richtlinie 89/336/EWG über die Elektromagnetische Verträglichkeit einschließlich der Änderungen 92/31/EWG und 93/68/EWG.

Bei Änderungen am Produkt, die nicht von uns autorisiert wurden, verliert diese Erklärung ihre Gültigkeit.

We declare the compliance of the device with the requirements of the Council Directive 89/336/EEC about the Electromagnetic Compatibility including modifications 92/31/EWG and 93/68/EWG.

Any modification to the product, not authorized by us, will invalidate this declaration.

Gerätebezeichnung/Device name:

Trimble DiNi

Normen/Standards:

EN 55022 Klasse B/ Class B

EN 61000-6-2

Grundlage – Konformitätsakte Nr./Basis –Record of Conformity No.: TJ 01/06

Das Gerät ist gekennzeichnet mit/ The device is marked with 

Prüfung/Test: **EMV-Labor/EMC-Laboratory Carl Zeiss Jena GmbH**

Registriert/Registered: **TJ CE_01-07_DiNi**

Jena, 15.01.2007

TRIMBLE JENA GMBH

Dr. Donath

Geschäftsführung
Site Management

Knorr

Leiter Qualitätssicherung
Manager Quality Assurance

Die Erklärung bescheinigt die Übereinstimmung mit der Richtlinie und dem Gesetz. Gewährleistung und Haftung sind in unseren Allgemeinen Lieferbedingungen geregelt.
The declaration certifies the compliance with the Directive and the Law. Conditions of guarantee and liability are dealt within our General Conditions of Sale.

Contents

Important Information	iii
Safety Information	iii
Battery Safety	iii
Environmental Information	iv
Equipment Information	v
Declaration of Conformity	vii
Trimble DiNi	vii
1 Introduction	1
Welcome	2
About the Trimble DiNi Digital Level	2
Related Information	2
Technical Assistance	2
Your Comments	3
Registration	3
2 Inspection, Care and Maintenance	5
Inspecting the Container	6
Instrument Case	6
Care and Maintenance	8
Cleaning	8
Getting rid of Moisture	8
Transporting the Instrument	9
Servicing	9
3 Instrument Description	11
Battery	12
Battery Safety and Environmental Information	12
Disposal	12
Charging the Li-Ion Battery	13
LED Indicators	13
Power (Green)	13
Temp (Red)	13
Contact (Amber)	13
Charge (Green)	13
Battery Charging Time	14
Instrument Battery Handling	14
Battery Capacity	14
Call up the Battery Capacity	14

Battery Low	15
Connecting the Internal Battery	16
Instrument Description.	18
Hardware Overview	18
Software Overview DiNi®	20
Main Menu DiNi®:	20
Keyboard and Display Description.	22
Keyboard.	22
Display	24
Principles of Keyboard and Display Functions.	26
Switching the Instrument On and Off	29
DiNi® Components	30
Compensator	30
Purpose	30
Function	30
Working Range.	30
Checking.	31
Angle Measuring System	31
Direct Measurement With DiNi	31
Height/Distance Measuring System	31
Acoustic Signal Generator.	31
Purpose	31
Memory	32
Data Safety.	32
Capacity DiNi®:	32
4 Setup	33
Setup	34
Setup Stability	34
Ambient Temperature	35
Setup and Coarse Centring	35
Setup	35
Coarse Centring (Only When Required)	36
Leveling and Fine Centring	36
Precision Leveling:	36
Fine Centring (Only When Required):	37
Telescope Focusing	37
Focusing the Cross Hairs:	37
Focusing the Target Point:	37
Switching the Instrument On and Off	37
Triggering Measurements	38
Configurating the DiNi	39
Input	39
Limits / Tests.	40
Adjustment.	41
Instrument Settings	42

Settings of Recording	44
Trimble Functions	46
Call up Stake out Point	46
Intermediate Sights	47
Measure Distance	47
Optical Measurement	48
Inverted Staff Measurements	50
Multiple Measurements	51
Input Comments	53
Illumination.	55
Illumination and Contrast	56
Version and Serial Number	57
5 Measuring Programs	59
Principles	60
Repetition of Measurements.	60
Search for Reference Heights in the Memory	61
Incremented and Individual Point Number.	63
Entering Code	64
Alphanumeric Input	64
Single Point Measurement (Without Reference Height)	66
Line Leveling.	68
Starting New Line / Continuing Line	69
Backsight and Foresight Measurements.	71
Intermediate Sights in Line Leveling.	74
Stake Out in Line Leveling.	75
Selectable and Automatic Controls During Line Leveling	76
Selectable Controls	76
Automatic Controls	77
Ending a Leveling Line.	78
With Known Height.	79
With Unknown Height.	79
Intermediate Sights	80
Stake Out	83
Stake Out	83
Measurement to Digital Graduation of Staff	86
Stake Out With Metrical Graduation of the Staff.	87
Line Adjustment	88
Line Adjustment (For Instrument Type 0.3mm/km Only)	88
6 Measuring Function.	93
Measuring Principles and Components	94
DiNi height measurement.	94
DiNi distance measurement.	94
Staff section in the leveling mode.	94

Staff code	94
Pendulum stop	95
Light conditions	95
Vibrations	96
Multiple Measurement	96
Hints for Precision Measurements.	97
Hints for Precision Leveling	97
Underground, Staff Sinking Into the Ground, Vertical Positioning, Turning 98	
Invar Staves	98
Hints for Precision Measurement - Area Leveling	98
7 Data Management	99
Data Management	100
Project Management.	101
Select a Project	102
Create a Project	103
Rename a Project	104
Delete a Project	105
Copy Between Projects	106
Editor	108
Searching Data Lines	109
Deleting Data Lines	110
Delete all Data	110
Deleting Selected Data Lines	112
Input of Data Lines.	114
Creating or Modifying the Three Code Lists.	115
Data Transfer	117
DiNi to PC	117
PC to DiNi	118
DiNi to USB Memory Stick.	119
Memory	120
Data Format	121
The M5 Data Record Format	121
The M5 Data Line	121
The Text Information in the M5 Format	123
The Type Identifier in the M5 Format	124
Definition of the Type Identifiers	124
Type Identifiers - Formats M5	124
Recording Data and Data Lines With DiNi.	126
8 Adjustment	129
Adjusting the Line of Sight.	130
Calling up the Adjustment Function	130
Förstner Method	131

Näbauer Method	132
Kukkamäki Method	132
Japanese Method	133
Making the Adjustment	133
Check the Function of Circular Bubble	136
Adjustment of Circular Bubble	137
9 Annex	139
Technical Data	140
Formulae and Constants	142
Correction of Staff Reading and Sighting Distance	142
Computation of the Line of Sight Correction.	142
Station Difference in Multiple Back- and Foresights.	142
Basis of Calculation for Line Adjustment	142
Update	144
Furnishing of Updates	144

Introduction

In this chapter:

- Welcome
- About the Trimble DiNi Digital Level
- Related Information
- Technical Assistance
- Your Comments
- Registration

Welcome

This manual describes how to set up and use the Trimble® DiNi® Digital Level.

Even if you have used other Digital Level products before, Trimble recommends that you spend some time reading this manual to learn about the special features of this product.

About the Trimble DiNi Digital Level

Although the principle of leveling has not changed, surveying today is no longer confined to the measurement of height differences. A demand now exists for complex measuring systems, which not only meet the increasing requirements for automatization, digital data processing and last but not least efficiency in everyday surveying, but which also set new standards in technology and operating convenience.

The DiNi fits excellently in the complete line of the measuring equipment from Trimble: Data interchange between all the instruments is ensured by a common data format and by the use of the USB Memory Stick.

Related Information

Sources of related information include the following:

- Trimble training courses – Consider a training course to help you use your Trimble Dini to its fullest potential. For more information, go to the Trimble website at www.trimble.com/training.html.

Technical Assistance

If you have a problem and cannot find the information you need in the product documentation, *contact your local dealer*.

If you need to contact Trimble technical support:

1. Go to the Trimble website (www.trimble.com).
2. Click the **Support** button at the top of the screen. The Support A–Z list of products appears.
3. Scroll to the bottom of the list.
4. Click the **submit an inquiry** link. A form appears.
5. Complete the form and then click **Send**.

Alternatively, you can send an e-mail to trimble_support@trimble.com

Your Comments

Your feedback about the supporting documentation helps us to improve it with each revision. E-mail your comments to ReaderFeedback@trimble.com.

Registration

To receive information regarding updates and new products please register on the Trimble web site.

www.trimble.com/register

Inspection, Care and Maintenance

In this chapter:

- Inspecting the Container
- Instrument Case
- Care and Maintenance
- Transporting the Instrument
- Servicing

Inspecting the Container

Inspect the shipping container. If the container arrives in poor condition, examine the equipment for visible damage. If damage is found, immediately notify the carrier and your Trimble sales representative. Keep the container and the packing material for the carrier to inspect.

Instrument Case

When unpacking the instrument, check that all ordered items are received. Below is an example of where all items can be placed in the instrument case.

Note – Some of the items in the picture below are optional.

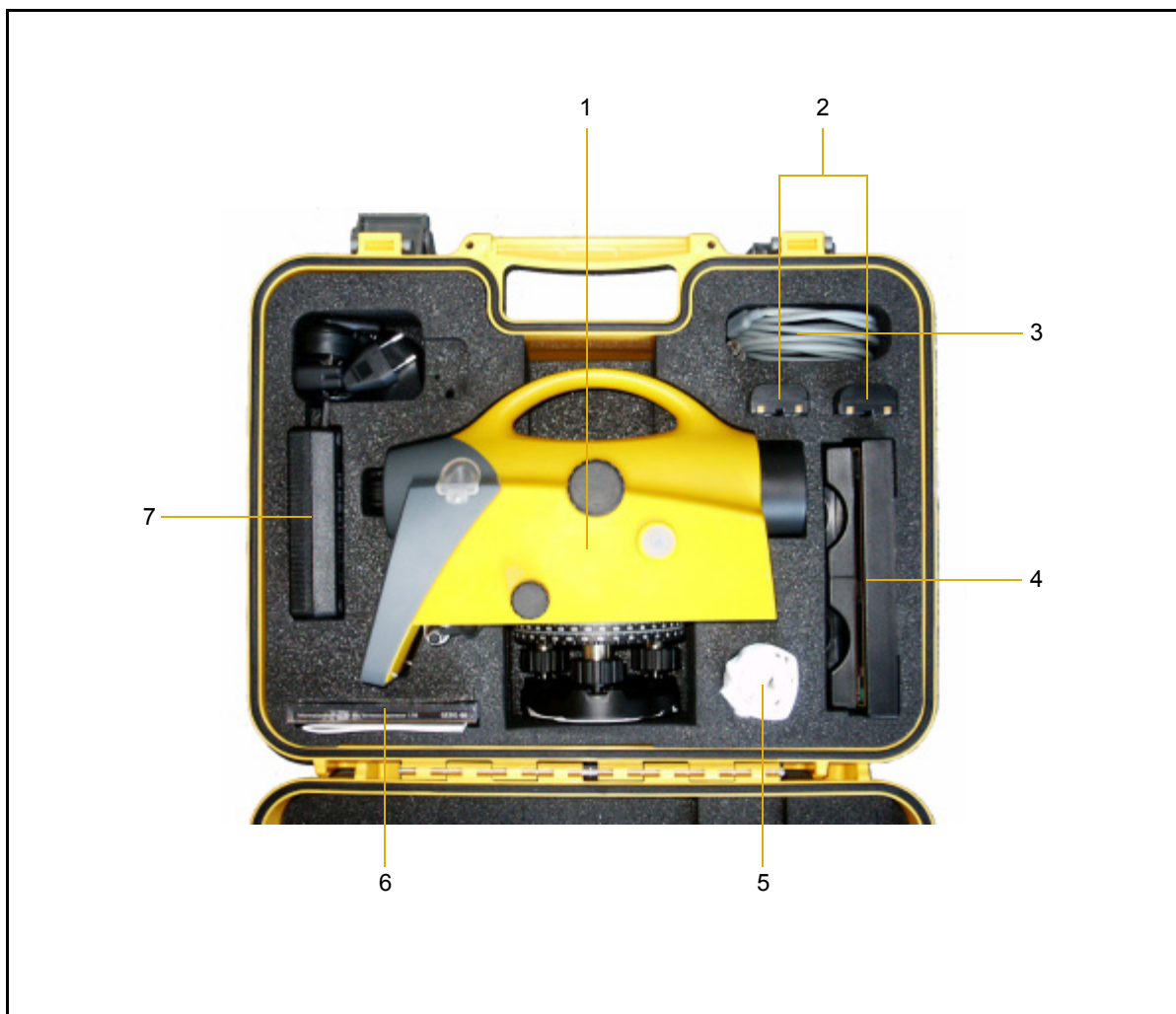

Figure 2.1 Instrument case

Item	Description
1	Trimble DiNi Digital level
2	Battery (One battery standard)
3	Cable (DiNi to PC)
4	Battery charger**
5	Rain cover
6	Manual CD, Short form user guide, certificate
7	Power supply for battery charger**
	Allen key for cross hair adjustment

** Optional

Care and Maintenance



WARNING – Do not remove the instrument cover from the instrument. Trimble DiNi is designed to withstand normal electromagnetic disturbance from the environment but it contains circuits that are sensitive to static electricity. If an unauthorized person opens the instrument cover, the function of the instrument is not guaranteed and the warranty invalidated.

The Trimble DiNi is designed and tested to withstand field conditions, but like all precision instruments, it requires care and maintenance. Take the following steps to get the best results from the instrument:

- Do not subject the equipment to rough jolts or careless treatment.
- Keep the lenses clean. Use only lens paper or other material that is designed for cleaning optical equipment.
- When not in use, keep the instrument in the instrument case.
- Carry the instrument by the handle.
- When you need extremely precise measurements, make sure that the instrument has adapted to the surrounding temperature. Significant variations in instrument temperature can affect precision.

Cleaning



CAUTION – Never use strong detergents such as benzine or thinners on the instrument or the instrument case.

Be very careful when cleaning the instrument, especially when removing sand or dust from lenses and reflectors. Never use coarse or dirty cloth or hard paper. Trimble recommends that you use anti-static lens wad, a cotton wad, or a lens brush.

Getting rid of Moisture

If the instrument has been used in damp weather, take the instrument indoors and remove the instrument from the instrument case. Leave the instrument to dry naturally. If condensation forms on the lenses, allow the moisture to evaporate naturally.

Transporting the Instrument

Always transport the instrument in a locked instrument case. For longer trips, transport the instrument in the instrument case and inside the original shipping container.

Servicing

Note – There are no user-serviceable parts in the Trimble DiNi

Trimble recommends that you take the instrument to an authorized Trimble service workshop for service and calibration once a year. This is to guarantee that the specified accuracies are maintained.

When you send the instrument to a service center, clearly write the name of the sender and the receiver on the instrument case. If repairs are required, enclose a note in the instrument case. The note should clearly describe any fault or symptoms, and indicate that servicing is required.

Instrument Description

In this chapter:

- Battery
- Charging the Li-Ion Battery
- Instrument Battery Handling
- Connecting the Internal Battery
- Instrument Description
- Keyboard and Display Description
- DiNi® Components

Battery

Before charging or using a battery it is important that you read and understand the battery safety and environment information.

Battery Safety and Environmental Information



WARNING – Do not damage the rechargeable Lithium-ion battery. A damaged battery can cause an explosion or fire, and can result in personal injury and/or property damage. To prevent injury or damage:

- Do not use or charge the battery if it appears to be damaged. Signs of damage include, but are not limited to, discoloration, warping, and leaking battery fluid.
 - Do not expose the battery to fire, high temperature, or direct sunlight.
 - Do not immerse the battery in water.
 - Do not use or store the battery inside a vehicle during hot weather.
 - Do not drop or puncture the battery.
 - Do not open the battery or short-circuit its contacts.
-



WARNING – Avoid contact with the rechargeable Lithium-ion battery if it appears to be leaking. Battery fluid is corrosive, and contact with it can result in personal injury and/or property damage. To prevent injury or damage:

- If the battery leaks, avoid contact with the battery fluid.
 - If battery fluid gets into your eyes, immediately rinse your eyes with clean water and seek medical attention. Do not rub your eyes!
 - If battery fluid gets onto your skin or clothing, immediately use clean water to wash off the battery fluid.
-



WARNING – Charge and use the rechargeable Lithium-ion battery only in strict accordance with the instructions. Charging or using the battery in unauthorized equipment can cause an explosion or fire, and can result in personal injury and/or equipment damage. To prevent injury or damage:

- Do not charge or use the battery if it appears to be damaged or leaking.
 - Charge the Lithium-ion battery only in a Trimble product that is specified to charge it. Be sure to follow all instructions that are provided with the battery charger.
 - Discontinue charging a battery that gives off extreme heat or a burning odor.
 - Use the battery only in Trimble equipment that is specified to use it.
 - Use the battery only for its intended use and according to the instructions in the product documentation.
-

Disposal

- Before disposal, discharge the battery.
- Dispose of the used battery in an environmentally sensitive manner, according to local and national regulations, see also Environmental Information page iv.

Charging the Li-Ion Battery

The Dual Li-Ion Battery Charger (P/N 41114-00) is designed to work specifically with the Trimble Universal Power Supply with an 18 V 3A rated output (P/N 48800-00). Use of a power supply other than that specified by Trimble can result in damage to the outer housing of the charger, or can reduce the battery life cycles due to insufficient voltage.

LED Indicators

The Dual Li-Ion Battery Charger LEDs show how the charging is operating.

Power (Green)

When power is supplied to the charger, the green power LED is lit. If the charger is not receiving power, or the power supply is not supplying enough voltage, the power LED is not lit.

Temp (Red)

When the charger is turned on, the charger monitors the temperature of the unit. If the unit becomes too hot, the Temp LED is lit.

The Temp LED is lit if the ambient temperature around the charger is extremely high causing the charger to stop charging. If this occurs, unplug the charger and do not attempt to continue charging until the ambient temperature is within the specified range (0 °C–40 °C).

Contact (Amber)

When a battery is inserted in the charger, the Contact LED is lit to indicate that the charger recognizes the battery and that it will be charged.

The battery must be fit properly in the charging slot or the Contact LED will not light.

If the Contact LED fails to light after you insert a battery into the charging slot, it may be that the battery voltage has dropped below the 5.6 V “sleep threshold”. If this occurs, apply a 12 V power supply to the battery for approximately 5 seconds and then place the battery in the charging slot. The charger should then recognize the battery and begin charging.

Charge (Green)

When you insert a battery and the charger recognizes it (the Contact LED is lit), the battery will be charged. The Charge LED has three modes to indicate the status of the battery, as follows.

LED	Battery Status
On (solid green)	Fully charged
Off (not lit)	Waiting to be charged
Flashing (alternating On/Off every 1 second)	Being charged

Battery Charging Time

The charger will begin operating as soon as a battery is inserted and recognized. The estimated charging time for Trimble batteries is as follows.

Battery	Estimated Charging Time
1.8 Ah	2.0-2.5 Hours
2.0 Ah	2.5-3.0 Hours
2.2 Ah	3.3-4.0 Hours
2.4 Ah	< 3.3 Hours

Instrument Battery Handling

Battery Capacity

Due to the implemented power management and the liquid-crystal graphic display, the DiNi uses very little energy. Depending on the age and condition of the battery, a charged Li-Ion 7.4 V 2.4 Ah battery lasts for about three days working time without illumination.

Call up the Battery Capacity

The current battery capacity is shown in the bar symbol on the top right of the display in a rough manner.

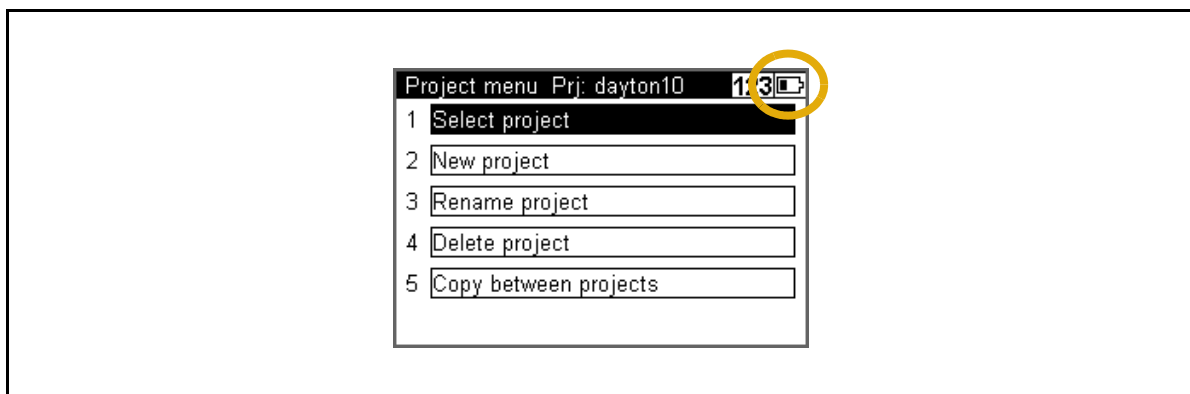

The precise condition of the battery can be called up in every measurement menu with the Function Field "Info"

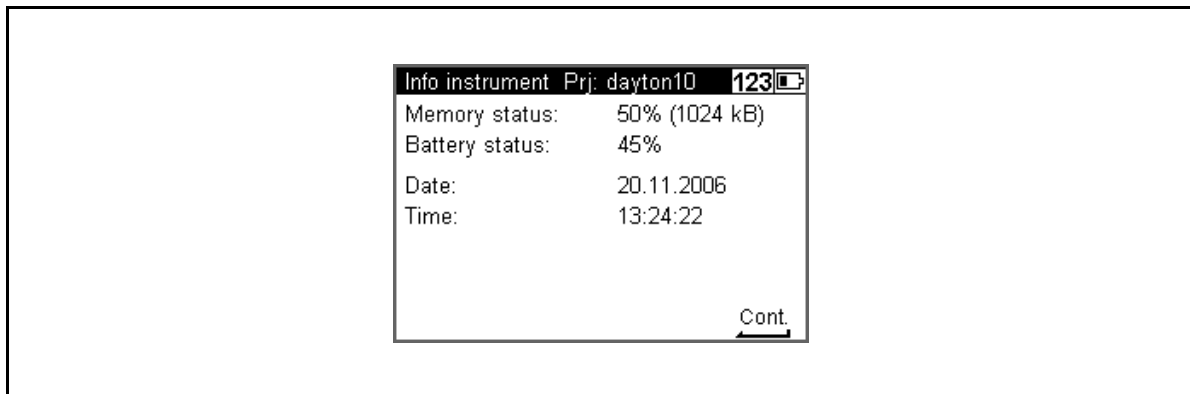

Battery Low

When the battery has run down, the message Battery power is below 10% appears in the display:

If this message is confirmed with key, several measurements can still be performed. As a reminder, the display briefly turns inverse with short intervals.

After this warning, a charged battery should be inserted as soon as possible. Make sure to switch off the instrument for the replacement. No data will be lost in this case.

If the battery is not changed the instrument will shut off automatically, without losing any data, when the battery has reached its lowest limit.

Connecting the Internal Battery



Figure 3.1 Opening battery compartment

1. Open the battery compartment by releasing the lock, see Opening battery compartment page 16.
2. Turn the compartment open, see Opening battery compartment page 16.

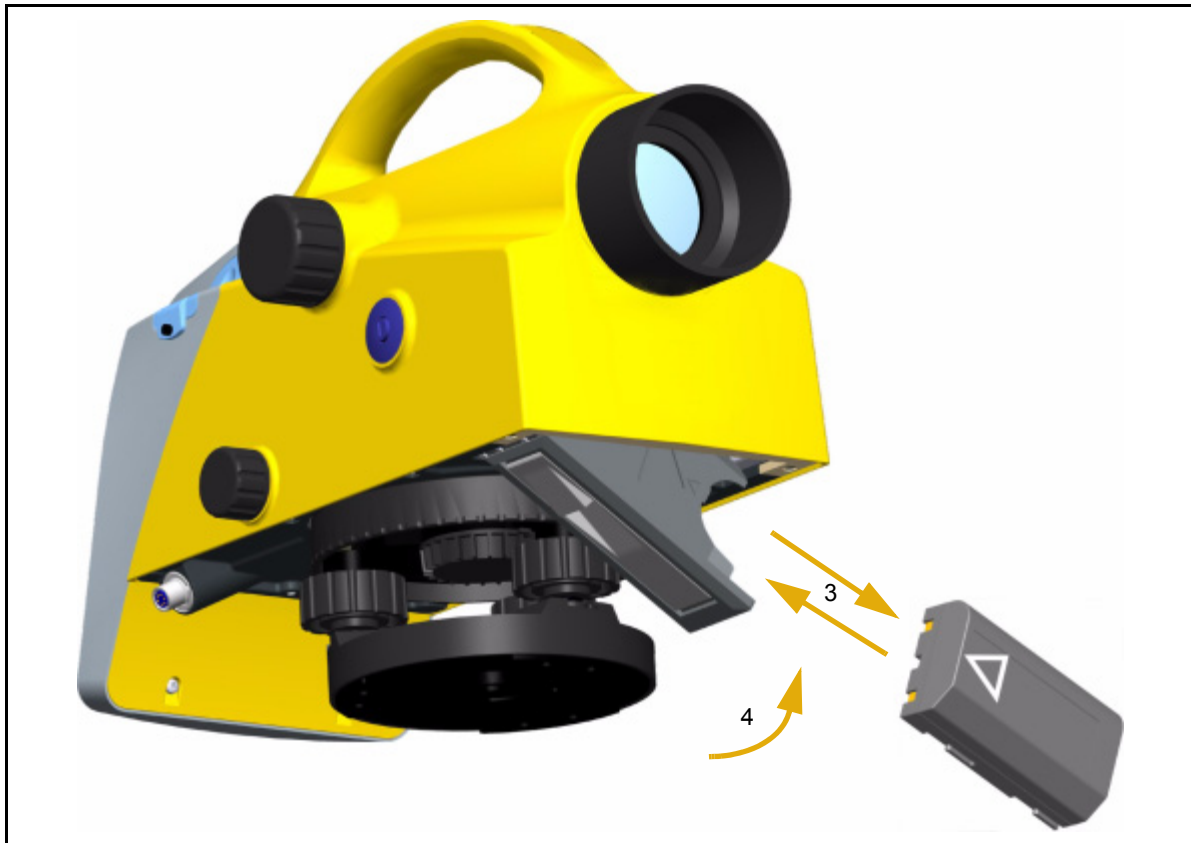

Figure 3.2 Inserting or removing the battery

3. The battery can now be removed or inserted.
4. Close the battery compartment until the lock clicks in place.

When changing the battery, take care that the battery does not fall down when you open the lock of the battery compartment (2).

Instrument Description

Hardware Overview

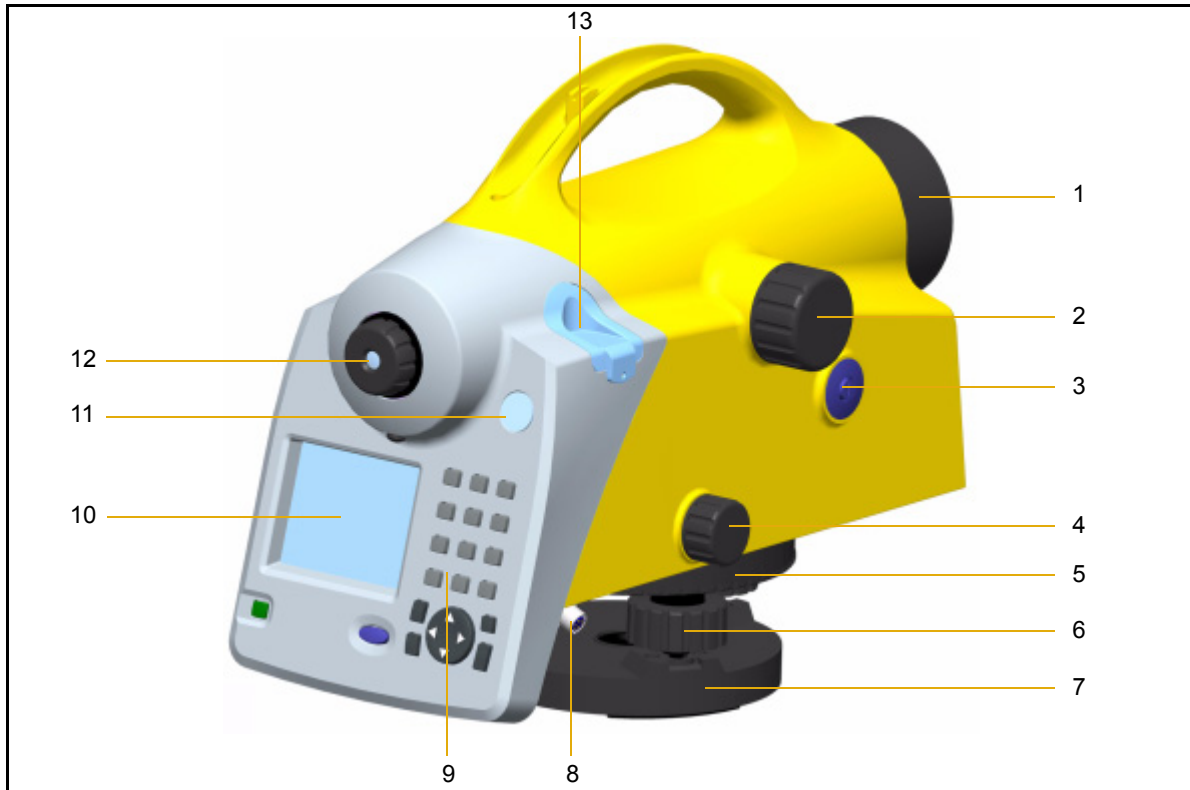

Figure 3.3 Instrument description

1. Telescope objective with integrated sun-shield
2. Telescope focusing knob
3. Trigger key
4. Horizontal tangent screw (endless slow motion drive)
5. Graduated circle
6. Footscrews
7. Tribrach
8. Power/Communication connector
9. Keyboard
10. Display
11. Window for circular bubble
12. Reticle
13. Cap, to be removed for adjustment of circular bubble



Figure 3.4 Instrument description, battery compartment

14. Battery compartment

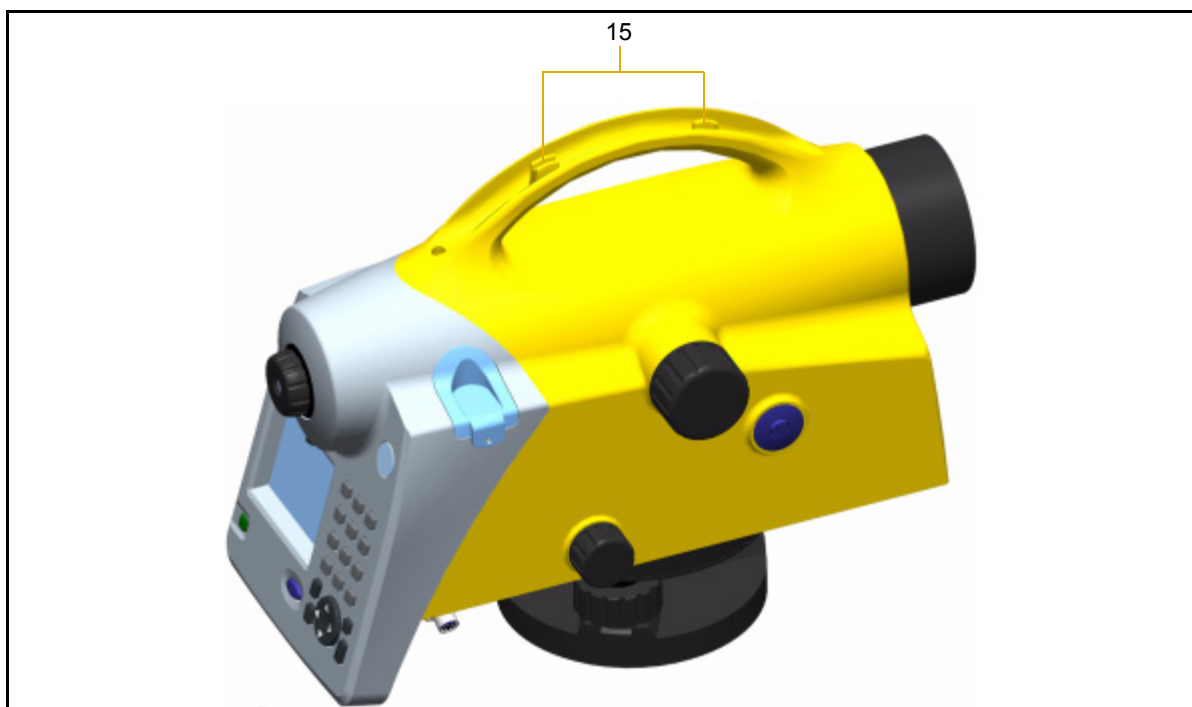

Figure 3.5 Instrument description, sight vane

15. Sight vane (notch and bead sights)

Software Overview DiNi®

Main Menu DiNi®:

*Note – *)Only Trimble DiNi 0.3mm/km*

Main Menu	Sub Menu	Sub Menu	Description
1 Files	Project Menu	Select Project	Select from a list of stored projects
		New Project	Start a new project
		Rename Project	Change the name of a stored project
		Delete Project	Delete a stored project
		Copy Between Projects	Copy information between two projects
	Editor		Edit stored data, enter and view data and enter and change code lists
	Data Im/ Export	DiNi to USB	Transfer data from the DiNi to a USB Memory Stick
		USB to DiNi	Transfer data from a USB Memory Stick to the DiNi
	Memory		Intenal and external memory. Total memory space, free memory space and format internal and external memory

Main Menu	Sub Menu	Sub Menu	Description	
2 Configuration	Input		Input of Refraction coeff., Addition const. (R), Date and Time	
	Limits/Tests		Input of different Limits and control settings.	
	Adjustment	Förstner Method		Line of sight adjustment.
		Nähbauer Method		Line of sight adjustment.
		Kukkamäki Method		Line of sight adjustment.
		Japanese Method		Line of sight adjustment.
	Instrument Settings		Settings for units in display and input, displayed last count, sound and language, date*) and time*).	
Settings of recordings		Settings of recording, type of recording (RMR or R-M), additional data (time*) or temperature*)) and point number increment.		
3 Survey	Single Point Measurement		Single Point Measurement	
	Line leveling		Line leveling	
	Intermediate Sights		Single point measurement with height stationing.	
	Stake out		Stake out	
	Continous measurements		Continous measurements	
4 Calculation	Line Adjustment		Line Adjustment*)	









CAUTION – When formatting the USB Memory Stick and internal memory all stored data will be lost.















Keyboard and Display Description

Keyboard

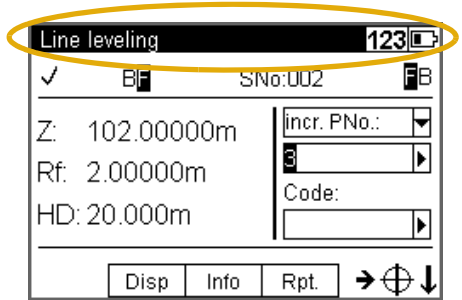
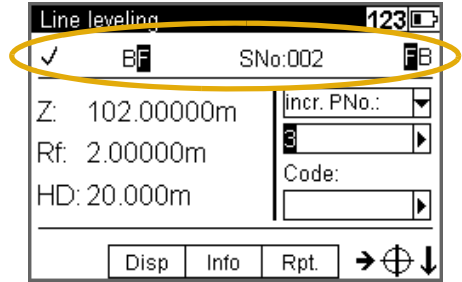
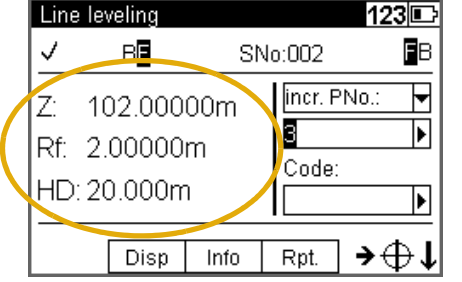
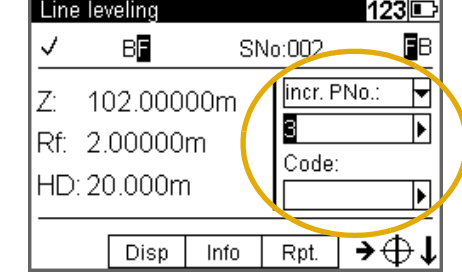

Figure 3.6 Control and display unit of DiNi®

Key	Description	Comment
	On/Off key	Switches the instrument on or off
	Trigger key	Starts a measurement
or		
		
	Spider key	Navigates through menus, shows drop-down lists and changes check box status
	Enter key	Confirms inputs
	Escape key	Returns to previous display/menu







Key	Description	Comment
	Alpha key	Switches the keyboard keys between primary and secondary function. Status are indicated at the top of the display.
	Trimble key	Displays the Trimble functions menu
	Back step key	to delete previous input
	Period and comma	Primary function: Period and comma Secondary function: Plus and minus (Press multiple times to get correct character)
	0 or Space key	Primary function: 0 Secondary function: Space
	1 or PQRS	Primary function: 1 Secondary function: PQRS (Press multiple times to get correct character)
	2 or TUV	Primary function: 2 Secondary function: TUV
	3 or WXYZ	Primary function: 3 Secondary function: WXYZ (Press multiple times to get correct character)
	4 or GHI	Primary function: 4 Secondary function: GHI (Press multiple times to get correct character)
	5 or JKL	Primary function: 5 Secondary function: JKL (Press multiple times to get correct character)
	6 or MNO	Primary function: 6 Secondary function: MNO (Press multiple times to get correct character)
	7	Primary function: 7 Secondary function:
	8 or ABC	Primary function: 8 Secondary function: ABC (Press multiple times to get correct character)
	9 or DEF	Primary function: 9 Secondary function: DEF (Press multiple times to get correct character)

Display

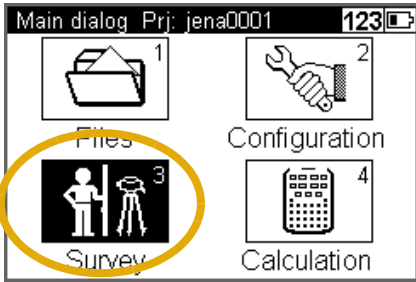
Display	Description
 <p>The screenshot shows the 'Line leveling' screen. The title bar at the top contains the text 'Line leveling' and the number '123' next to a battery icon. Below the title bar, there is a status bar with a checkmark, 'BF', 'SNo:002', and another 'BF' icon. The main display area shows 'Z: 102.00000m', 'Rf: 2.00000m', and 'HD: 20.000m'. To the right of these values are three input fields: 'incr. PNo.:', a field with the number '3', and 'Code:'. At the bottom, there are buttons for 'Disp', 'Info', 'Rpt.', and navigation icons.</p>	<p>Information regarding current program, input and battery status.</p>
 <p>This screenshot is identical to the first one, but the status bar containing the checkmark, 'BF', 'SNo:002', and the second 'BF' icon is circled in yellow.</p>	<p>Information regarding workflow status. Sample shows Line levelling</p>
 <p>This screenshot is identical to the first one, but the measurement values 'Z: 102.00000m', 'Rf: 2.00000m', and 'HD: 20.000m' are circled in yellow.</p>	<p>Result of the latest measurement</p>
 <p>This screenshot is identical to the first one, but the three input fields on the right ('incr. PNo.:', the field with '3', and 'Code:') are circled in yellow.</p>	<p>Input of information connected to the next measurement</p>

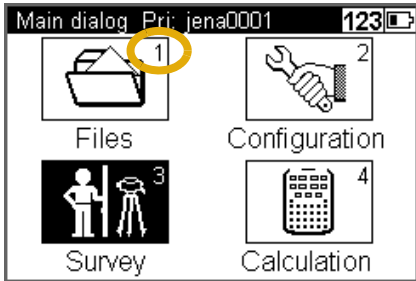
Display	Description
	<p>Function field and information area.</p>
	<p>When all information connected to the next measurement are entered this symbol will appear to indicate that the instrument is ready to measure</p>
	<p>This symbol will appear as a reminder when the instrument is set to measure towards an inverted staff.</p>

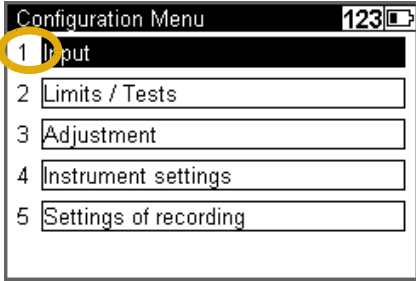
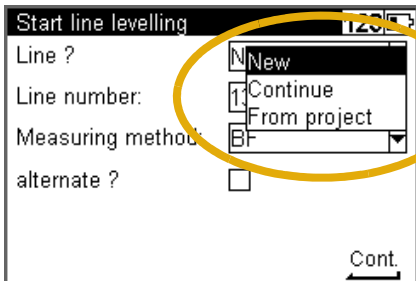
Principles of Keyboard and Display Functions

Display	Key function and description
	<p>Navigate with the  spider key in the display menus to highlight the item you want to select.</p>
	<p>To confirm a selection press the  enter key or go directly by pressing the number of the selection e.g.  number 1 key</p>
	
	<p>Some input fields are marked with a drop down-arrow to indicate that input selections are made from a pre-defined list. Press the right arrow on the  spider key to select from a drop-down list, press enter to confirm. Press the left arrow on the  spider key to step through the possible selections</p>

Display

Key function and description

Start line levelling 123

Line ? New

Line number: 1

Measuring method: BF

alternate ?

Cont.

Some input fields are open for alpha and numeric inputs from the user.

Type in the input of your choice with the instrument keyboard. Switch between numeric, capital letters or lowercase letters by pressing the alpha key. The status is indicated at the top of the display.

Start line levelling 123

Line ? New

Line number: 1

Measuring method: aBF

alternate ?

Cont.

Some inputs are made with a check box.

Navigate with the spider key in the display to highlight the check box.

Press the left arrow on the spider key to select or unselect.

Line leveling 123

✓ BF SNo:002 FB

Z: 102.00000m

Rf: 2.00000m

HD: 20.000m

Incr. PNo.:

Code:

Disp Info Rpt.

Navigate with the spider key up, down, left or right.

Line leveling 123

✓ BF SNo:002 FB

Z: 102.00000m

Rf: 2.00000m

HD: 20.000m

Incr. PNo.:

Code:

Disp Info Rpt.

In this part of the display you can navigate with the spider key up or down through the different input fields and down to the softkeys at the bottom of the display. When an input field is highlighted you can press the right arrow on the spider key to select from a drop-down list or press the left arrow on the spider key to step through the possible selections

Display	Key function and description
---------	------------------------------

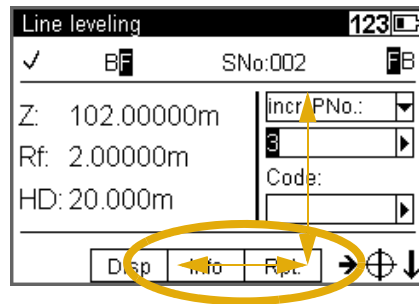

In this part of the display you can navigate with the spider key left or right to highlight different soft keys. Press Enter to select the highlighted soft key function.

To be able to go back up to the input fields you must first highlight the Soft key located directly under the input fields, press up or down on the spider key

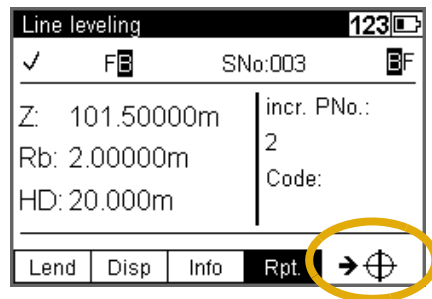

The symbols displayed in the bottom corner of the display indicates the next step.

Symbol

= Ready to measure
press /
measurement key

Select = Press enter key to select a detail

Store = Press enter key to store measurement

Accept = Press enter key to accept

Cont. = Press enter key to continue

Copy = Press enter key to copy data

Page 2 = Press enter key to continue to next screen

= Press spider key up or down arrow to show further data lines

Switching the Instrument On and Off

 switching on and off

A properly charged battery is necessary for the operation of the instrument. Switch on the instrument with the  key. After a short display of the Logo, the instrument is ready for measurement. The Main menu or the uncomplete application is always displayed.

DiNi[®] Components

Compensator

Purpose

Correction of the current line of sight inclination by a mechanical compensator

Function

Automatic alignment of the compensator ensures that an inclined line of sight is automatically leveled within the working range both for visual observation and internal electronic measurement. The compensator cannot be deactivated.

Working Range

The working range of the compensator is $\pm 15'$ with a setting accuracy of $\pm 0.2''$ or $\pm 0.5''$ depending on instrument type. If the inclination range is exceeded a symbol of a non centered bubble will be shown in the top line of the display.

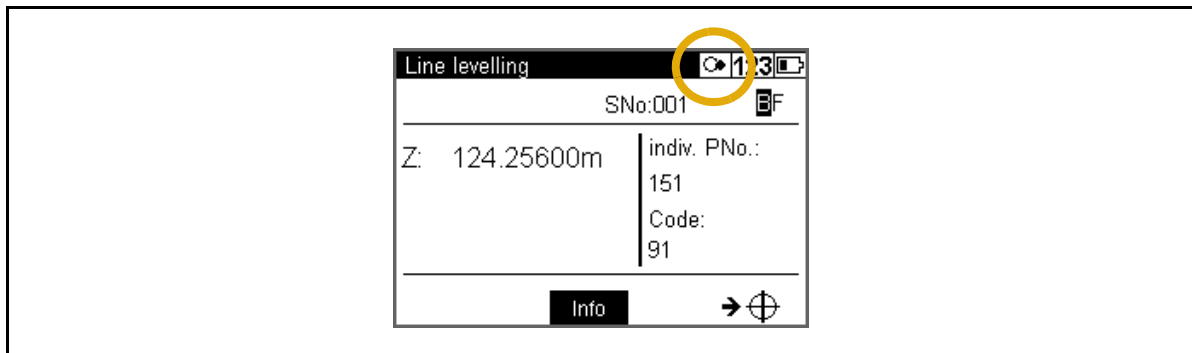

A warning information is generated and has to be confirmed after releveing the instrument

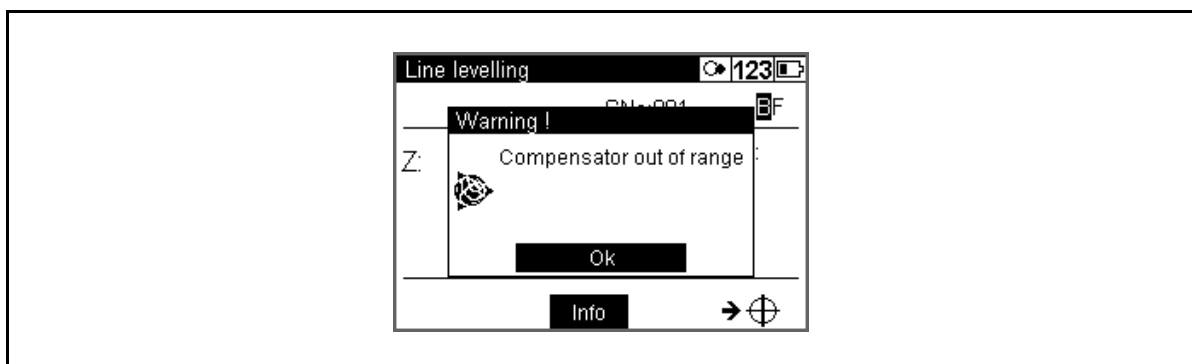

Checking

The compensator has a major influence on the instrument's line of sight. For run centre adjustment, determine the residual line of sight inclination to permit distance-dependent correction of the measured values. For this, the Adjustment menu option on DiNi provides four methods. For precise height measurements, this check should be performed at regular intervals

see Adjustment Chapter 8

Angle Measuring System

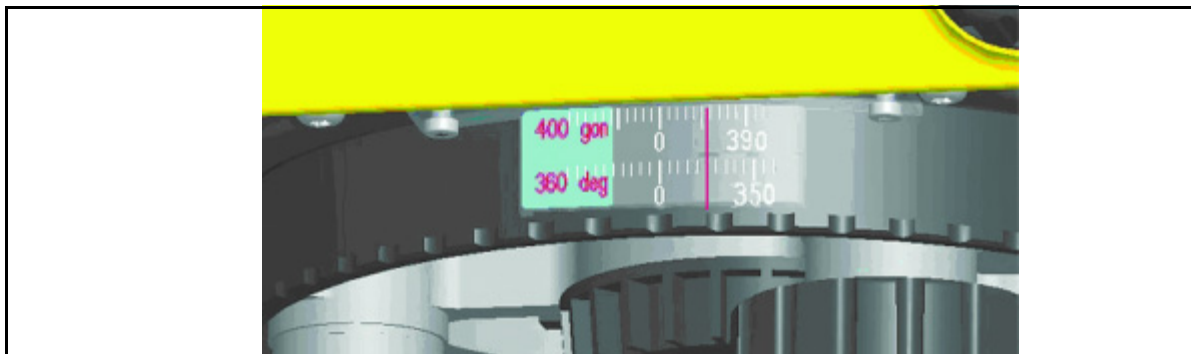

Figure 3.7 Angle measuring system

Direct Measurement With DiNi

You can perform simple direction measurements and stake-outs. You can read the direction without any aid by means of an index line on the horizontal circle. The circle is graduated to 1 degree and 1 gon, estimated readings are possible down to 0.1 degrees and 0.1 gon

Height/Distance Measuring System

For details see Measuring Programs Chapter 5

Acoustic Signal Generator

Purpose

Confirmation of functions and warning signal when system messages are displayed.

Sound signals:

- Key function Klick
- Multiple measurements, interims value Di
- Data if a complete measurement Diii

- Error message Diiiiiii
- Battery power below 10% Di, Di, Di

With USB Memory Stick connected

- Connect the device or open communication Da, Di
- Disconnect the device or open communication Di, Da
- File operation was successfully Dii, Di

The sound can be activated or deactivated in the instrument settings menu, see Instrument Settings page 42

Memory

The permanent memory of the DiNi[®] stores computation constants, operating modes, measuring units, etc. even after instrument shutoff.

The measured data and additional information is stored in the internal memory.

Data Safety

Data storage in the internal memory (non-volatile data memory without buffer battery) offers data safety for unlimited time.

Capacity DiNi[®]:

The capacity of the internal data memory depends on the measuring mode, a line leveling with method BFFB will consume more lines than a single measurement.

It amounts to approx. 30 000 data lines.

Setup

In this chapter:

- Setup
- Configuring the DiNi
- Trimble Functions

Setup

An instrument setup with good measuring stability will increase the precision in the measurement result and allow you to utilize the measurement precision of the Trimble DiNi to its full extent.

Setup Stability

When a level is setup it is important to consider the following:

1. Set tripod legs wide apart to increase the stability of the setup. A setup where one leg is placed on e.g asphalt and the other two on soil will still be a stable setup provided that the tripod legs are set wide enough. If it is not possible to set the tripod legs wide apart due to obstacles, then the tripod can be lowered to increase stability.

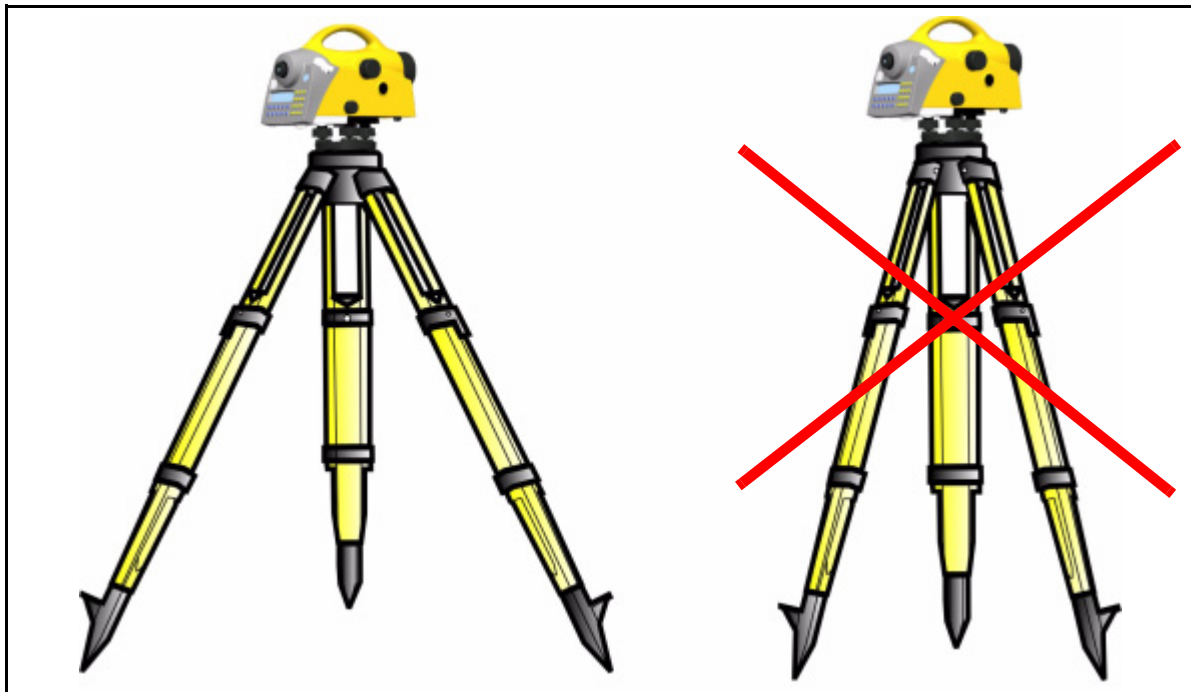

Figure 4.1 Setup stability

2. Make sure that all the screws on the tripod and/or tribrach are tightened to avoid any play.
3. Any survey quality tripod can be used. However, Trimble strongly recommends the use of tripod heads made of steel, aluminium or similar material. Tripod heads of fiberglass or other composite materials are not recommended.



Tip – Trimble offers tripod part number 707255000000 with fixed, non extendable legs. This tripod is recommended in some regions for leveling highest order lines.

Ambient Temperature

Take into account that a level requires sufficient time to adjust to the ambient temperature. The following rule-of-thumb for a high precision measurement applies: Temperature difference in degree Celsius ($^{\circ}\text{C}$) $\times 2 =$ duration in minutes required for the instrument to adjust to the new temperature.

Avoid sighting across fields with intense irradiation by sun light, e.g. at noon.

Setup and Coarse Centring

In order to guarantee the stability of measurement we recommend the use of a Trimble tripod.

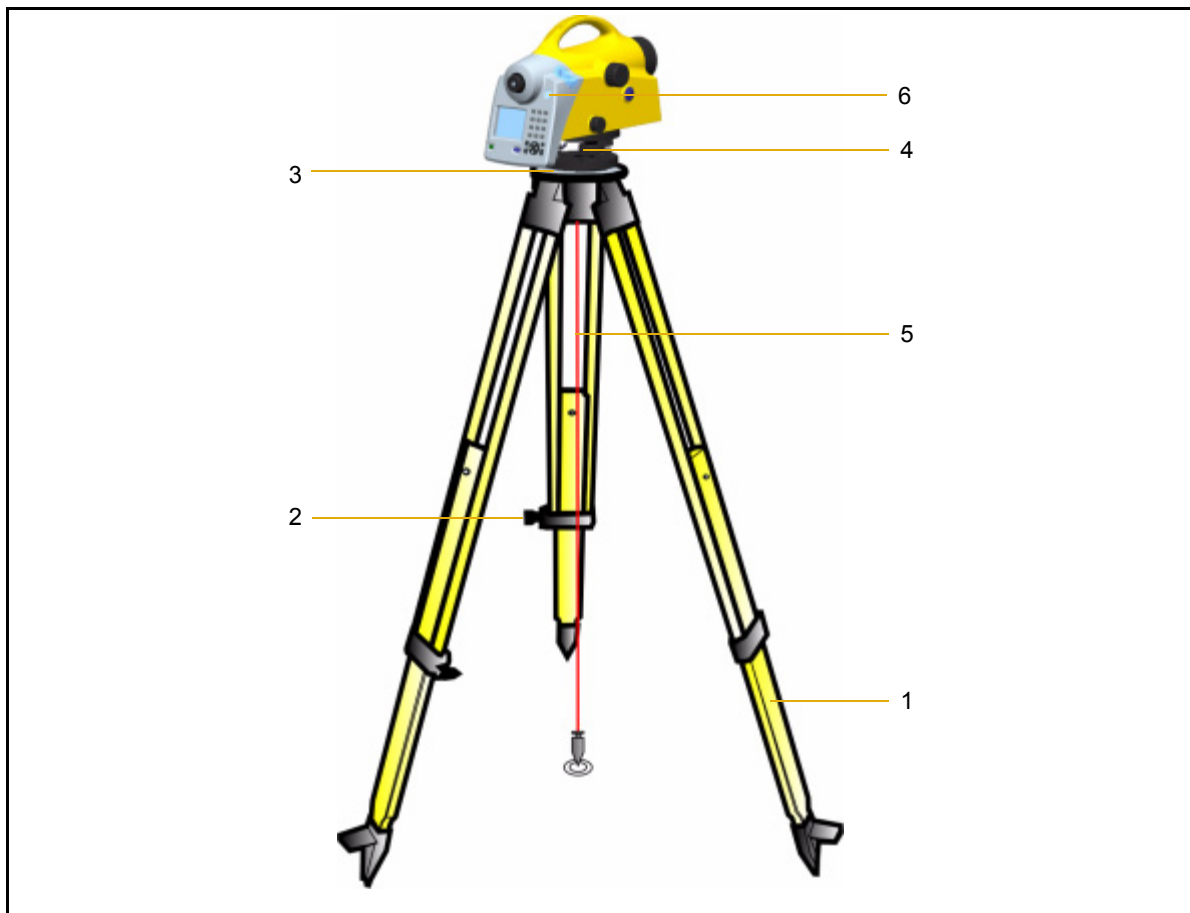

Figure 4.2 Setup and coarse centring

Setup

Extend the tripod legs (1) to a comfortable height of observation and fix them using the tripod locking screws (2). Screw the instrument centrally to the tripod head plate (3). The tribrach screws (4) should be in mid-position.

Coarse Centring (Only When Required)

Set up the tripod roughly above the station point (ground mark). The tripod head plate (3) should be approximately horizontal.

Hook the plumb line (5) into the retaining screw and set up the tripod roughly centred above the ground mark.

Leveling and Fine Centring

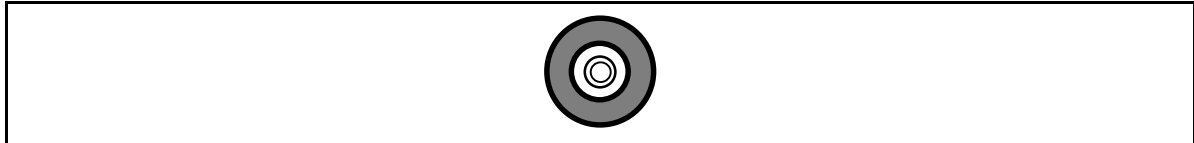

Figure 4.3 Levelling and fine centring

Coarse leveling:

Level the circular bubble (6) by adjusting the length of the tripod legs (1).

Precision Leveling:

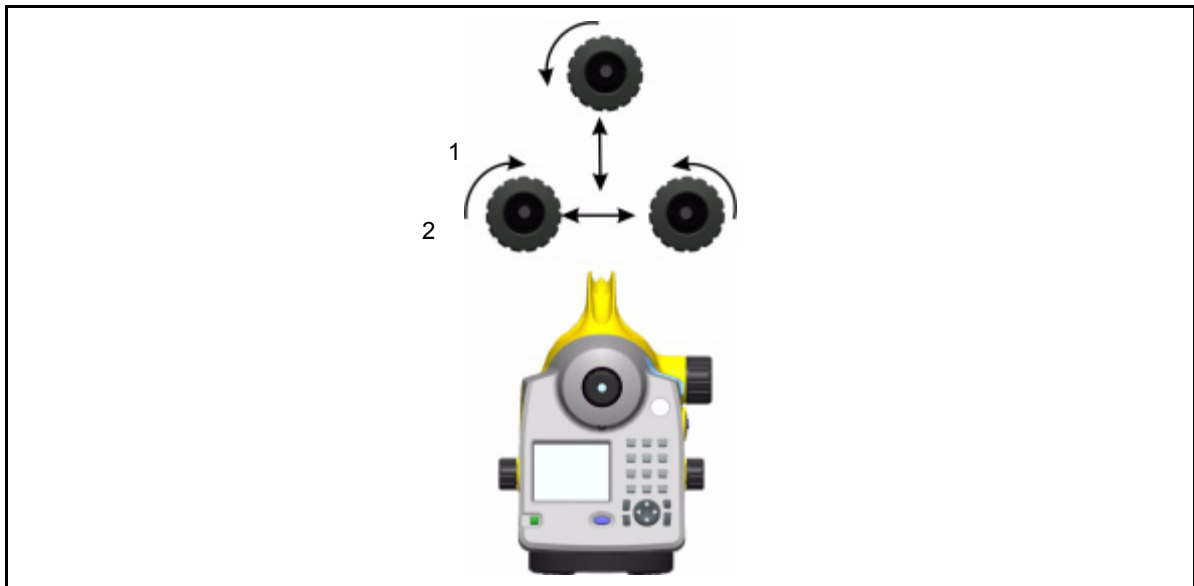

Figure 4.4 Precision leveling

Align the control unit parallel with the imaginary connecting line between two tribrach screws. Level the instrument in the telescope axis (1) and rectangularly to it (2) by means of the tribrach screws. For checking, turn the instrument round the vertical axis in the diametrical position. In any case, the residual inclination should be within the working range of the compensator ($\pm 15'$) after having centred the circular bubble.

Fine Centring (Only When Required):

Shift the tribrach on the tripod head plate until the plumb line is hanging centrally above the ground mark; repeat the leveling various times, if necessary.

Telescope Focusing

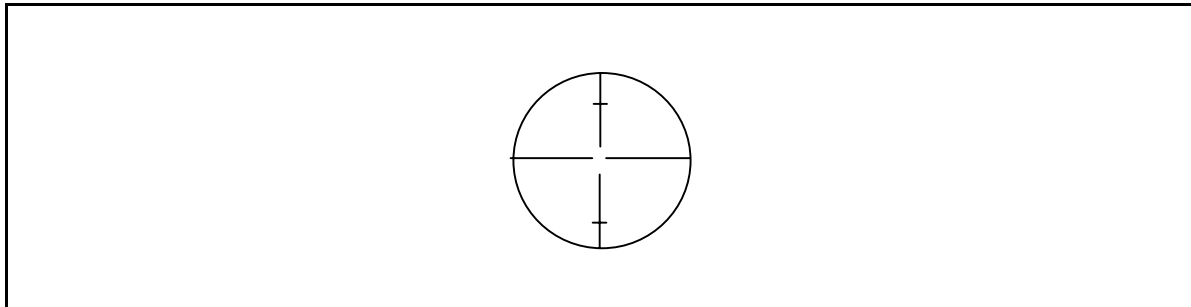

Figure 4.5 Visual field DiNi®

Focusing the Cross Hairs:

Sight a bright, evenly coloured surface and turn the telescope eyepiece until the line pattern is sharply defined.



WARNING – Sighting of the sun or strong light sources *must by all means be avoided* because it would cause irreparable damage to your eyes.

Focusing the Target Point:

Turn the telescope focusing control unit until the target point is sharply defined.



Tip – Check the telescope parallax: If you move your head slightly whilst looking through the eyepiece, there must be no relative movement between the cross hairs and the target; check focusing, if necessary.





WARNING – Residual inclinations of the line of collimation remaining after having centred the circular bubble are eliminated by means of the compensator. But it does not compensate any inclinations caused by insufficient adjustment of the circular bubble or of the line of collimation. For this reason, both adjustments have to be checked.

Switching the Instrument On and Off

To switch the instrument on or off press the  on/off key.

Operating the OFF function unintentionally does not lead to a loss of measured values. The system will ask in case of certain functions, but on principle, all current values (line leveling) are saved in a non-volatile working memory.

Triggering Measurements

The  Trigger key on the keyboard or the  Trigger key on the right side of the instrument will start a measurement.

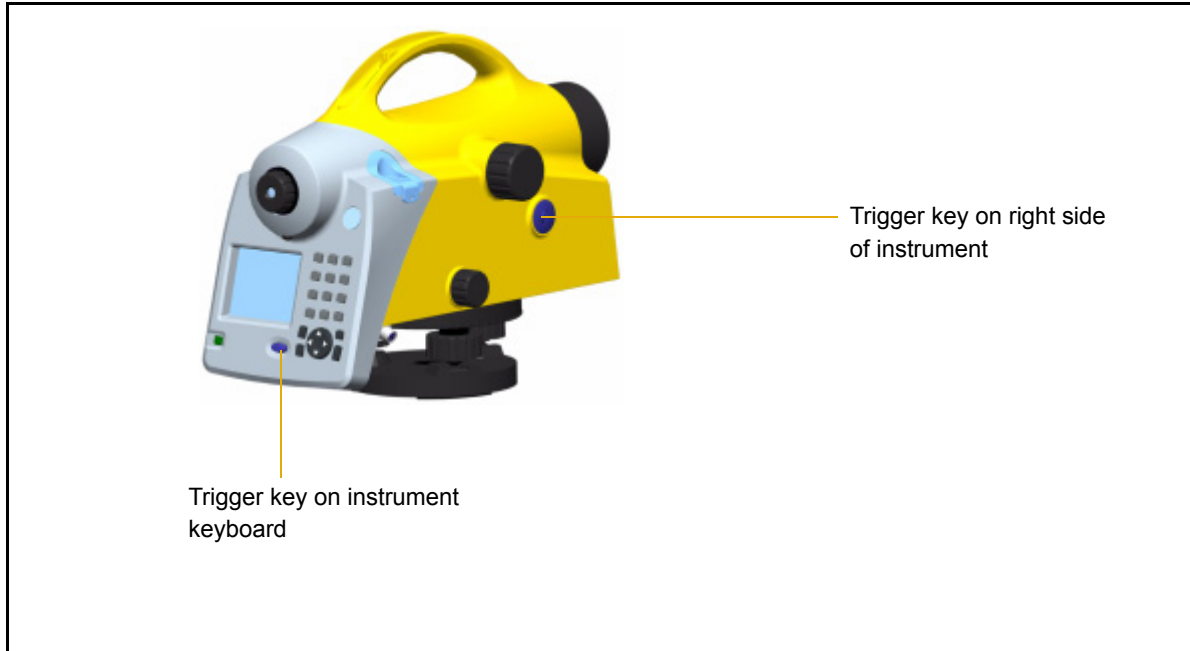
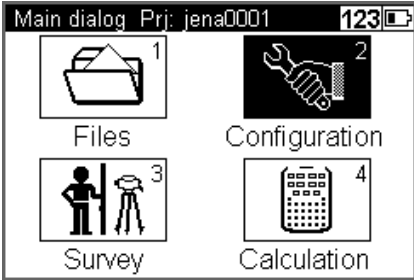

Figure 4.6 Triggering measurements

***Note** – For high precision measurements, Trimble recommends to use the trigger key on the right side of the instrument. This trigger key is designed to minimize the influence of any vibrations caused by touching the instrument when pressing the trigger key to start a measurement.*



Configuring the DiNi

In the configuration menu it is possible to set all general instrument settings and make the instrument adjustments.

Actions	Screen	Comments
To configure the DiNi, select Configuration		

Input

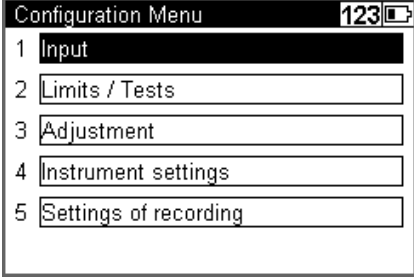
Under Input it is possible to set the Refraction coeff., Addition constant (R), Date and Time.

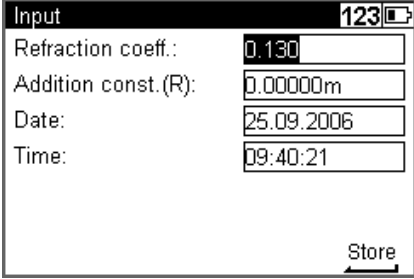
Actions	Screen	Comments
Select Input from the Configuration menu		
Key in the Refraction coeff., Addition constant (R), Date and Time of your choice and press  enter key to Store.		Refraction coeff.: -1 - + 1 Addition const.(R): 0 m - 5 m

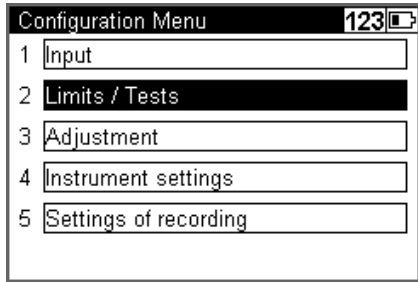
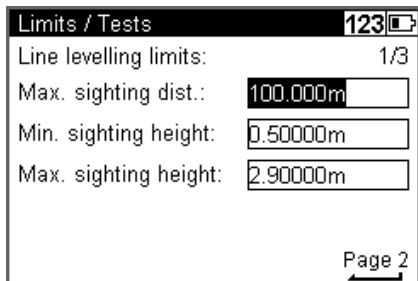
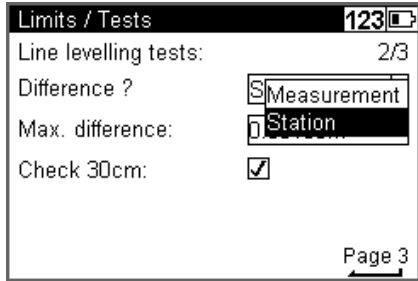

Limits / Tests

Note – Only for Line Leveling, except the 30cm control

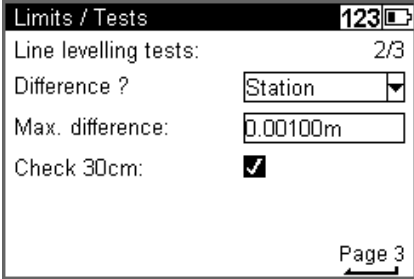
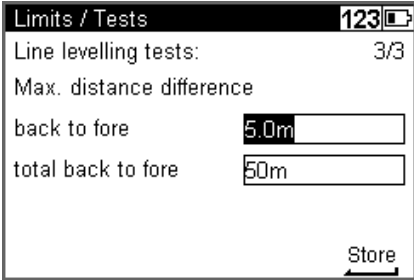
Actions	Screen	Comments
Select Limits / Tests from the Configuration menu		
Key in the Max. sighting dist., Min. sighting height and Max. sighting height of your choice and press ↓ enter to continue to Page 2.		Max. sighting dist. range: 10m - 100m Min. sighting dist. range: 0m - 1m Max. sighting height range: 0m - 5m
Select Difference from the drop-down list.		Station = B1-F1 to B2-F2 Measurement = B1 to B2 and F1 to F2

Actions	Screen	Comments
Key in the Max. difference of your choice. Select or clear the Check 30 cm check box and accept with  enter.		Max. difference range: 0m - 0.01m
Key in the Max. distance of your choice for a station (back to fore) and for the whole line (total back to fore).		Range 0m - 5.0m Range 0m - 100m

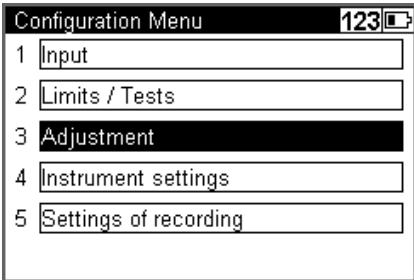

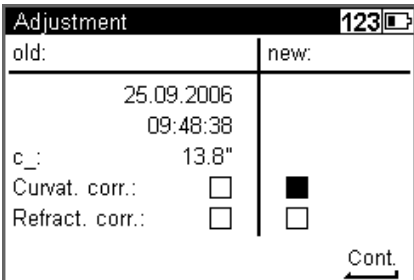
Adjustment

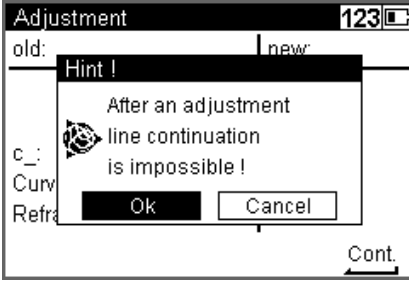
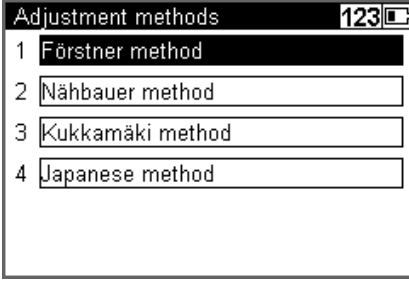
Actions	Screen	Comments
Select Adjustment from the Configuration menu.		
The old adjustment value and information are displayed. Select Curvature and/or refraction correction on or off during adjustment. Press  enter to Continue		

Actions	Screen	Comments
<p>Select Ok to continue or Cancel to abort the adjustment</p>		<p>Note – After an adjustment is made line continuation is impossible.</p>
<p>Select the adjustment method of your choice.</p>		<p>For more information please see Adjusting the Line of Sight on page 130.</p>

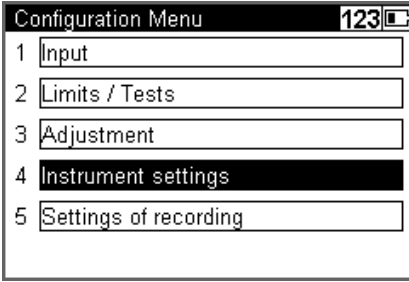
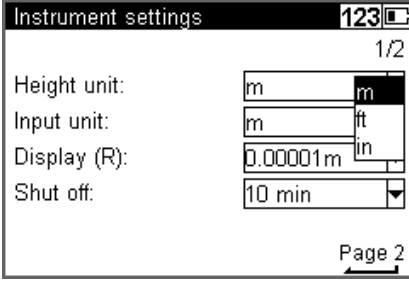
Instrument Settings

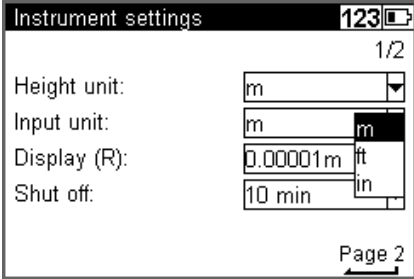
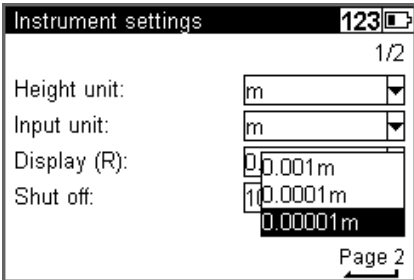
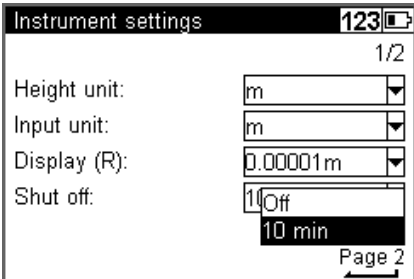
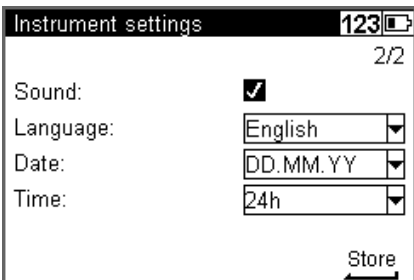



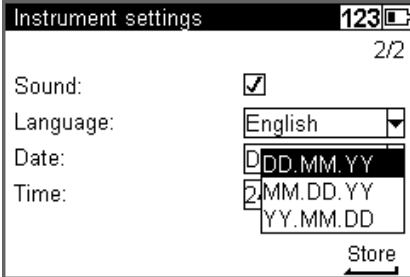
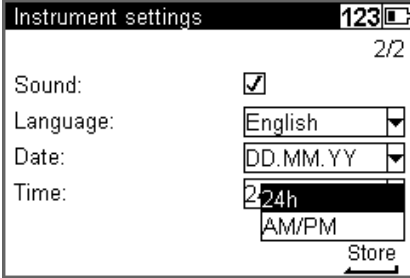

Actions	Screen	Comments
<p>Select Instrument Settings from the Configuration menu.</p>		
<p>Select Height unit.</p>		<p>m=meter ft=foot (US Survey foot) in=inches</p> <p>Note – It is possible to enter a single height in another unit without changing the default setting by manually adding the abbreviation of the unit after the value.</p>

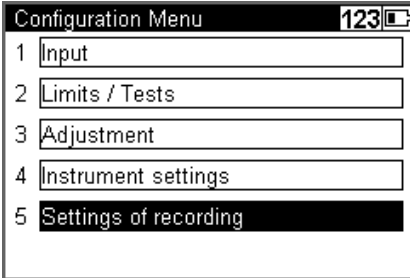
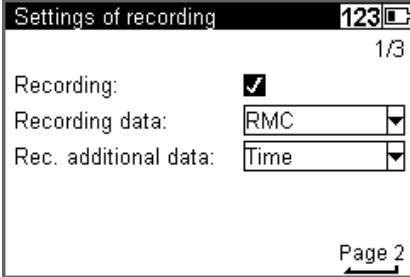
Actions	Screen	Comments
<p>Select Input unit.</p>	 <p>The screenshot shows the 'Instrument settings' screen with 'Input unit' set to 'm'. Other settings include Height unit: m, Display (R): 0.00001m, and Shut off: 10 min. A 'Page 2' indicator is at the bottom right.</p>	<p>m=meter ft=foot in=inches</p>
<p>Select the number of decimals that will be displayed, Display (R).</p>	 <p>The screenshot shows the 'Instrument settings' screen with the 'Display (R)' dropdown menu open, showing options: 0.0001m, 0.00001m, and 0.000001m. Other settings are the same as in the previous screenshot. A 'Page 2' indicator is at the bottom right.</p>	<p>Note – The instrument will still measure and save the values with the full number of decimals.</p>
<p>Select 10 min, to switch Off the instrument after 10 minutes without any key press</p>	 <p>The screenshot shows the 'Instrument settings' screen with the 'Shut off' dropdown menu open, showing options: Off and 10 min. Other settings are the same as in the previous screenshots. A 'Page 2' indicator is at the bottom right.</p>	<p>The automatic switch Off will not work while using:</p> <ul style="list-style-type: none"> • Continuous measurement. • Instrument connected to USB Memory Stick or PC.
<p>Select or clear the Sound check box to turn the sound on or off.</p>	 <p>The screenshot shows the 'Instrument settings' screen with the 'Sound' checkbox checked. Other settings include Language: English, Date: DD.MM.YY, and Time: 24h. A 'Store' button is at the bottom right.</p>	
<p>Select the display Language.</p>	 <p>The screenshot shows the 'Instrument settings' screen with the 'Language' dropdown menu open, showing options: English and German. Other settings are the same as in the previous screenshots. A 'Store' button is at the bottom right.</p>	<p>Languages will be changed after confirming the selection</p>

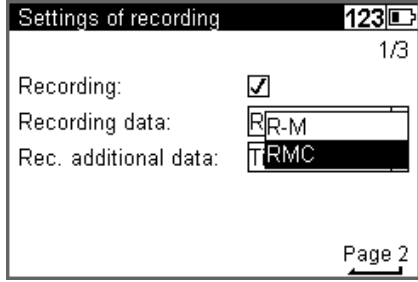
Actions	Screen	Comments
Select the Date system.		D=Day M=Month Y=Year
Select the Time system.		

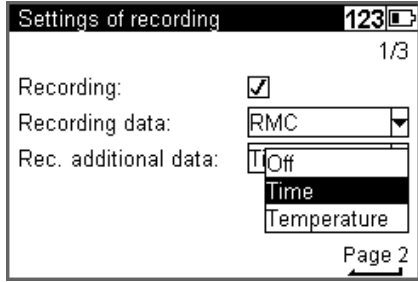
Settings of Recording

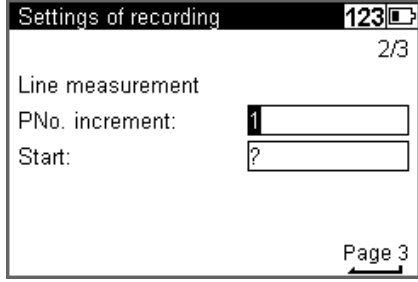
Actions	Screen	Comments
Select Settings of Recording from the Configuration menu.		
Select or clear the Recording check box to turn on or off the recording.		

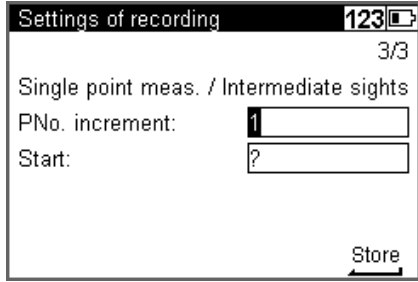
Actions	Screen	Comments
Select Recording Data.		<p>R-M=Only the measured values are saved</p> <p>RMC=The measured and calculated values are saved.</p> <p>Note – RMC must be set to be able to adjust the level line after measurement</p>
Select Rec. additional data. Press  enter to continue to Page 2.		<p> Tip – Date and Time will be stored in instrument, type 0.3mm/km only</p>
<p>Number system Line measurement:</p> <p>Enter PNo. Increment and Start number.</p> <p>Press  enter to confirm and continue.</p> <p>See Incremented and Individual Point Number on page 63</p>		<p>The start number will count with the PNo.increment.</p>
<p>Number system Single point measurement / Intermediated sights:</p> <p>Enter PNo. Increment and Start number.</p> <p>Press  enter to confirm and continue.</p> <p>See Incremented and Individual Point Number on page 63</p>		<p>The start number will count with the PNo.increment.</p>

Trimble Functions

The Trimble Functions menu can be reached at all stages by pressing the  Trimble icon key. The following functions are available.

Note – All functions are not available at all times, the available functions in the Functions Menu are related to the selected program.

Actions	Screen	Comments
Press the  Trimble icon key.		

Call up Stake out Point

During Line leveling it is possible to stake out a point.

Actions	Screen	Comments
Select SOut.		See Stake Out on page 83 for further information.

Intermediate Sights



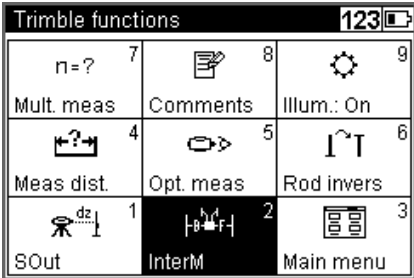

During Line leveling it is possible to measure a single point.

Actions	Screen	Comments
Select InterM.		Single Point Measurement (Without Reference Height) on page 66

Measure Distance

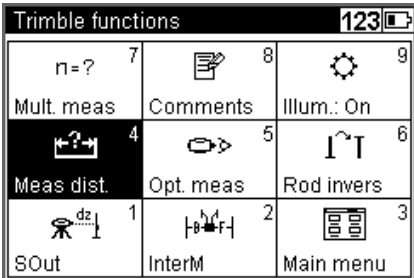
Sometimes it is necessary to know the distance to the staff before doing the final measurement - e.g. in a Line leveling it is necessary to know a distance to the staff to adjust the total distance for backsight and foresight.

With the Measure Distance function it is possible to measure only the distance to a point.

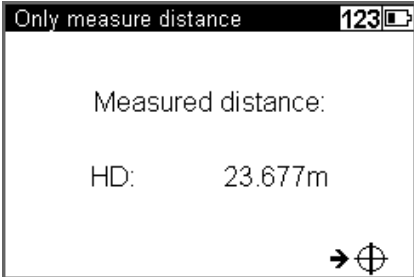
Actions	Screen	Comments
Select Meas dist.		
Press the  /  trigger key to measure. Press  Escape to return to the program.		

Optical Measurement

In some cases, when a digital measurement is not possible, the input of an optical measurement from a metrical staff may become necessary. The readings can then manually be keyed in for this point.

Note – Take into account that an optical measurement is less precise than a digital measurement and that the adjusting measurement has been carried out electronically (reticle shifted to the nominal value according to electronic adjustment) - (identity of electronic and optical horizon).

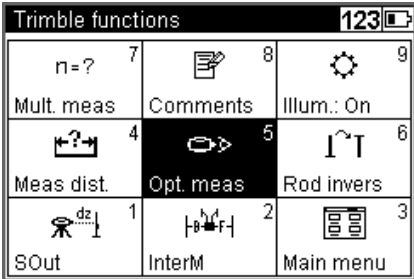
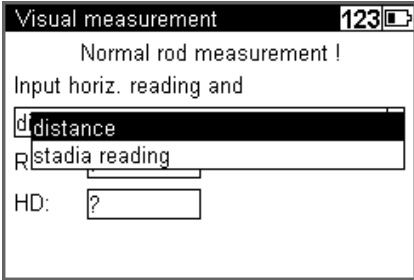
Actions	Screen	Comments
<p>Select Opt. meas.</p>		
<p>Select if you want to key in the Distance value or if you want to use Stadia readings</p>		

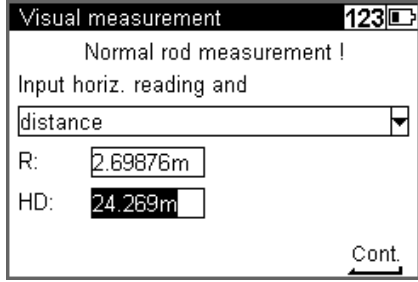
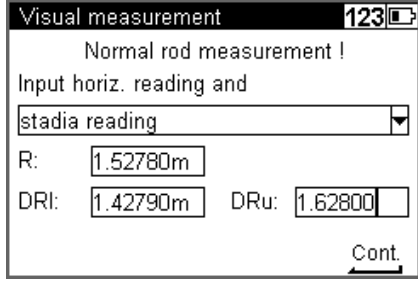
Actions	Screen	Comments
<p>If Distance is selected, key in the horizontal reading HD and the rod reading R. Press ↵ enter key to Continue.</p>		
<p>If Stadia reading is selected, key in the stadia reading values and the rod reading R. Press ↵ enter key to Continue.</p>		<p>Stadia readings = The readings from the upper and lower Reichenbach stadia lines</p>

Inverted Staff Measurements

Inverted measurements are required for work underground and inside buildings, the staff base is turned upwards. The inverted staff measurement will be set for all measurements made until this setting is changed.

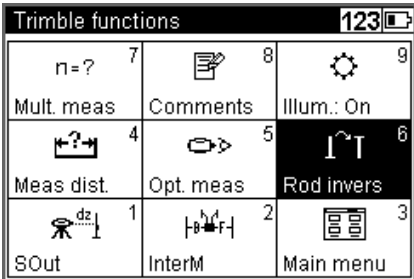
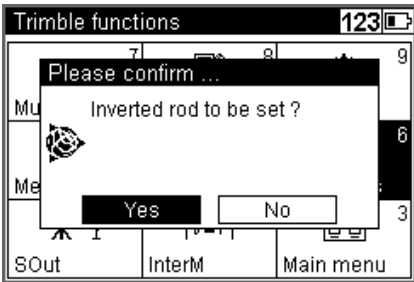
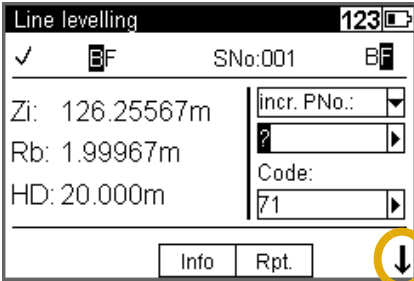
Actions	Screen	Comments
Select staff invers.		
Select Yes to confirm inverted staff setting		Yes = Inverted staff No = Normal staff
		When inverted staff is set an arrow pointing downwards will be shown in the lower right corner of the display.

Multiple Measurements

Repeated measurements (nM) and Standard deviation (mR) can be defined to be sure that the required accuracy is reached.

nM=1	One measurement only
nM>1; mR=0	Performance of all measurements
nM>1; mR>1	Performance of measurements until number of repetitions or standard deviation has been reached

In repeat measurements, the mean values of staff reading and distance and the standard deviation are displayed after each measurement.

If the standard deviation has been defined, at least three measurements are performed.

When the desired standard deviation has been obtained, the process can be stopped, but take into account that vibrations to the instrument by the key depression have to be avoided - otherwise the last value would falsify the result.

The standard deviation can be saved, but must be defined in Setting of recordings.

Note – In this case, line adjustments are not possible.

The number of measurements is always saved.

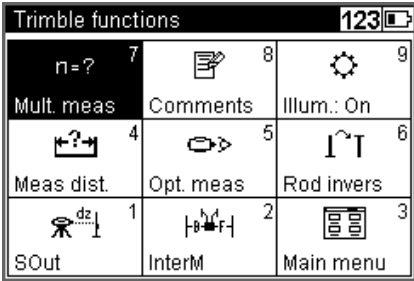
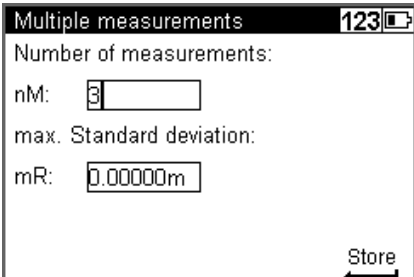
Actions	Screen	Comments
Select Mult. meas.		
Key in the number of measurements nM.		<p>nM = The number of measurements that the instrument will make before a result is accepted. Maximum = 10 measurements.</p>

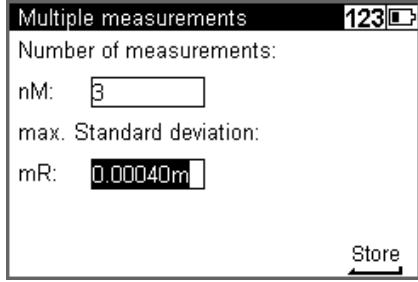
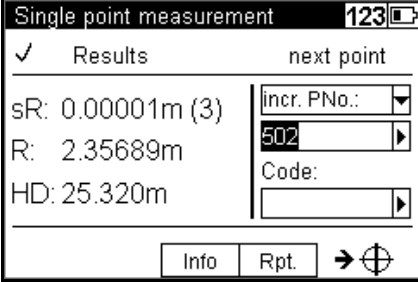
Actions	Screen	Comments
<p>Key in the standard deviation mR. Press  enter key to Store.</p>	 	<p>mR = The maximum standard deviation to be reached before a result is accepted. A minimum of three measurements will be made.</p>

Input Comments

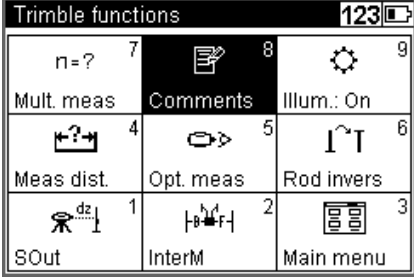
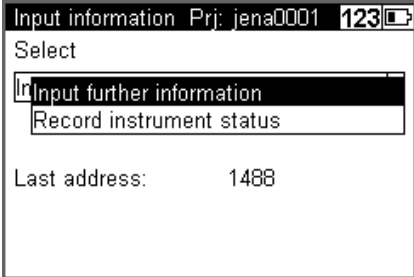
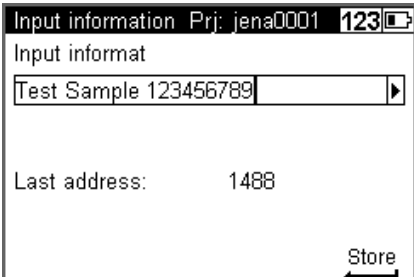
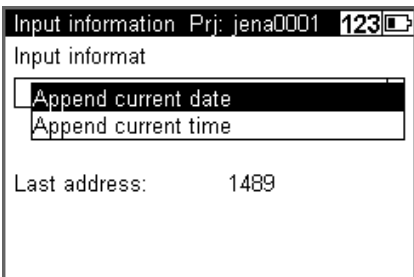

Whenever it is necessary during the measurement alphanumeric text information including date and time can be entered successively.

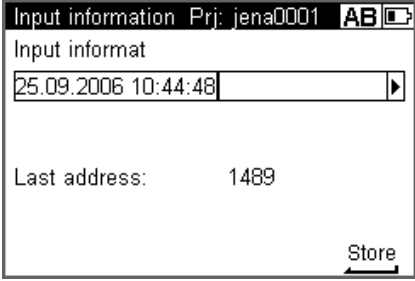
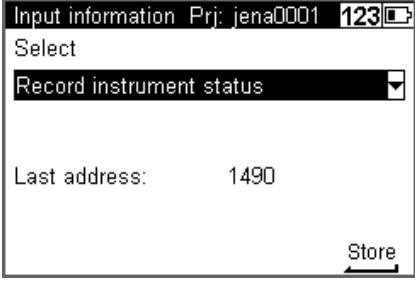
Actions	Screen	Comments
Select Comments.		
Select Input further information		
It is now possible to enter alpha and numeric signs		
To add current date or time to the information, select Append current date and/or Append current time.		

Actions	Screen	Comments
Press  enter key to store the information.		
<p>With this command it is possible to document the basic status of the instrument. Data lines with the following contents are then successively recorded:</p> <ul style="list-style-type: none"> • Measuring unit • Amount of the line of sight correction • Date of last adjustment • Earth curvature / refraction setting - Refraction coefficient • Staff offset/addition constant to quit the instrument information 		

Illumination

With the Illumination function it is possible to switch the display and/or bubble illumination On or Off.

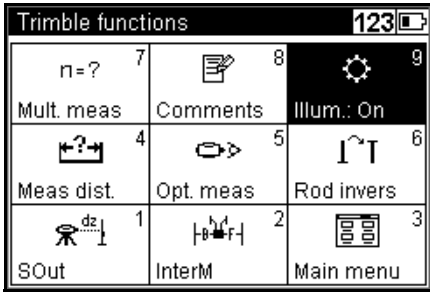
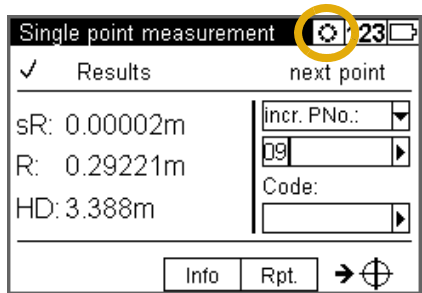
Actions	Screen	Comments
<p>Select Illum. Switch between illumination On Or Off with the  enter key or  number 9 key</p>		
<p>A symbol will be shown as long as the illumination is switched ON</p>		<p>Using the Power Safe mode, the instrument will switch Off the illumination after 30 second. The symbol sun will be changed to symbol moon. With the next keypress the light will be On and the function behind the keypress will be ignored</p>

Illumination and Contrast

In this screen it is possible to set the illumination on or off for the display and/or bubble. The brightness of the illumination, The contrast of the display and Power safe mode.

Actions	Screen	Comments
---------	--------	----------

Press **0** key

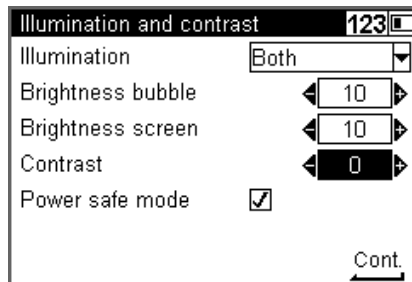

In the Illumination drop down list it is possible to select if you want illumination on Bubble only, Screen only or Both

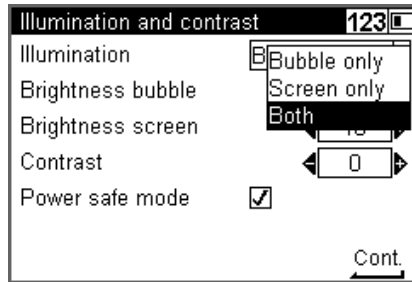

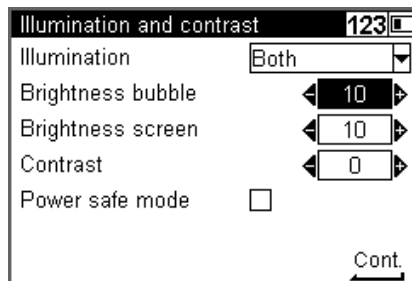

To change the brightness of the bubble illumination highlight Brightness bubble and use the right and left arrow on the spider key to increase or decrease bightness.



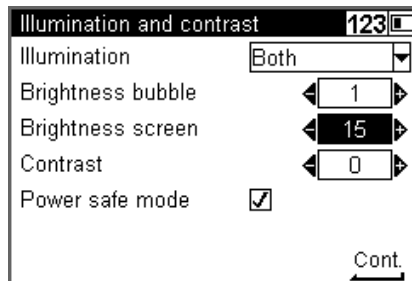

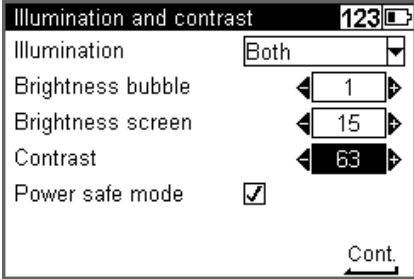
To change the brightness of the screen illumination highlight Brightness screen and use the right and left arrow on the spider key to increase or decrease bightness.

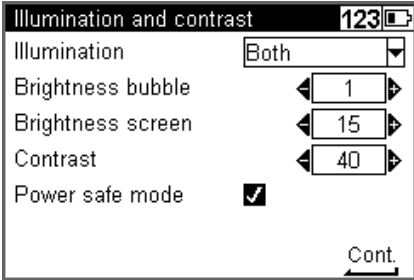

Actions	Screen	Comments
To change the contrast of the screen highlight Contrast and use the right and left arrow on the  spider key to increase or decrease contrast.		
Select or clear the Power safe mode check box to turn on or off. press  enter key to confirm your settings		

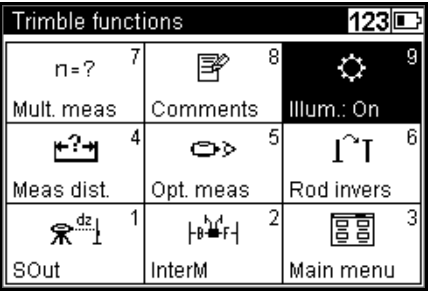
Version and Serial Number

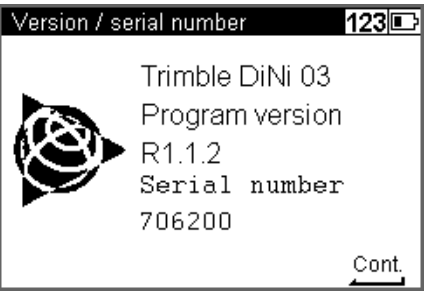
Actions	Screen	Comments
Press  dot/comma key.		
The Program version and Serial number are displayed. Press  enter key to Continue to the Main dialog.		

Measuring Programs

In this chapter:

- Principles
- Single Point Measurement (Without Reference Height)
- Line Leveling
- Intermediate Sights
- Stake Out
- Line Adjustment

Principles

Repetition of Measurements

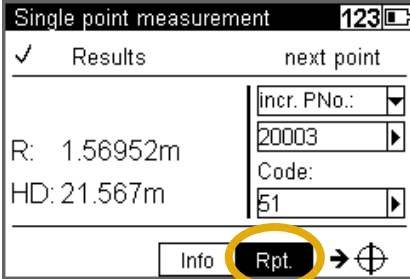
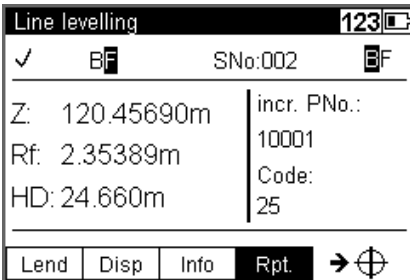
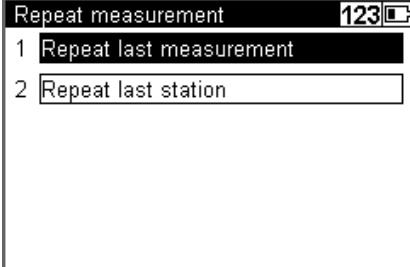
Actions	Screen	Comments
Select the function field Rpt., press  enter to confirm.		Note – The last measurement can be repeated in each case
e.g. line leveling. Select the function field Rpt. confirm with Enter		In this case, the original data lines are marked with ##### in the code range of PI and not used for computing.
Select the appropriate function		As far as it is reasonable from a technical point of view, the last station (line leveling) can be repeated as well.

Search for Reference Heights in the Memory

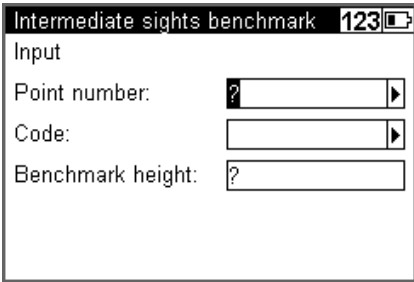
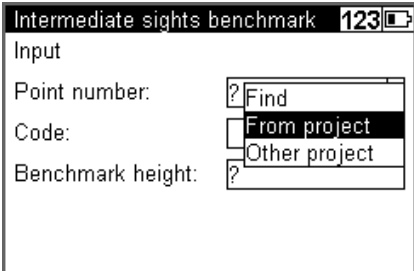
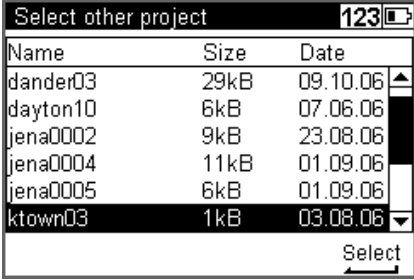
Actions	Screen	Comments																					
Key in Point number	 <p>The screenshot shows a screen titled "Intermediate sights benchmark" with a numeric keypad icon in the top right. Below the title is the word "Input". There are three input fields: "Point number:" with a question mark icon, "Code:" with a question mark icon, and "Benchmark height:" with a question mark icon.</p>	Using the input function all fields can be entered																					
Select from where the reference height is selected	 <p>The screenshot shows the same screen as above, but with a dropdown menu open over the "Point number:" field. The menu contains three options: "Find", "From project" (which is highlighted), and "Other project".</p>	From project offers points in the selected "working" project. Other projects offers the selection for all other projects																					
Select the requested project	 <p>The screenshot shows a screen titled "Select other project" with a numeric keypad icon in the top right. It displays a list of projects with the following columns: Name, Size, and Date. The projects listed are: dander03 (29kB, 09.10.06), dayton10 (6kB, 07.06.06), jena0002 (9kB, 23.08.06), jena0004 (11kB, 01.09.06), jena0005 (6kB, 01.09.06), and ktown03 (1kB, 03.08.06). A "Select" button is at the bottom right.</p> <table border="1" data-bbox="683 1104 1098 1339"> <thead> <tr> <th>Name</th> <th>Size</th> <th>Date</th> </tr> </thead> <tbody> <tr> <td>dander03</td> <td>29kB</td> <td>09.10.06</td> </tr> <tr> <td>dayton10</td> <td>6kB</td> <td>07.06.06</td> </tr> <tr> <td>jena0002</td> <td>9kB</td> <td>23.08.06</td> </tr> <tr> <td>jena0004</td> <td>11kB</td> <td>01.09.06</td> </tr> <tr> <td>jena0005</td> <td>6kB</td> <td>01.09.06</td> </tr> <tr> <td>ktown03</td> <td>1kB</td> <td>03.08.06</td> </tr> </tbody> </table>	Name	Size	Date	dander03	29kB	09.10.06	dayton10	6kB	07.06.06	jena0002	9kB	23.08.06	jena0004	11kB	01.09.06	jena0005	6kB	01.09.06	ktown03	1kB	03.08.06	All projects available in order of created time.
Name	Size	Date																					
dander03	29kB	09.10.06																					
dayton10	6kB	07.06.06																					
jena0002	9kB	23.08.06																					
jena0004	11kB	01.09.06																					
jena0005	6kB	01.09.06																					
ktown03	1kB	03.08.06																					

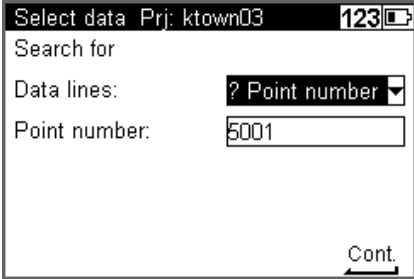
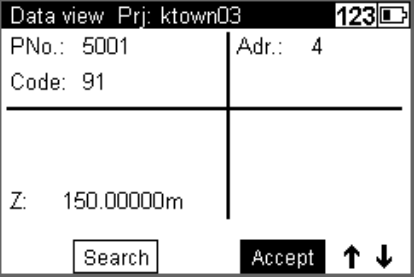
Actions	Screen	Comments
<p>Key in Data lines. With cursor left or right define the search criteria for the point and define the point.</p>		<p>The selected project is visible in the Status line.</p>
<p>Confirm the selected point or search with spider key up and down arrows to find further lines with identical criterias.</p>		<p>Select Search</p>

Incremented and Individual Point Number

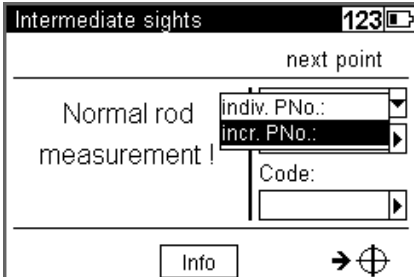
Actions	Screen	Comments
<p>Key in line incr. PNo Select with cursor left or right and down incr. PNo. or indiv. PNo.</p>		<p>The function allows toggle between the input of incremented and individual point numbers. The incremented number is incremented by your setting, normally 1.</p> <p>The user has two count systems for incremented point numbers. One for Line leveling points and one for Intermediate points. The start number and the increment has to be defined, see Settings of Recording on page 44</p> <p>After using an individual point number the system will switch to the incremented value used before. In line levelings, the input of the number of the start point and end point is requested. The point number has 8 digits.</p>

Entering Code

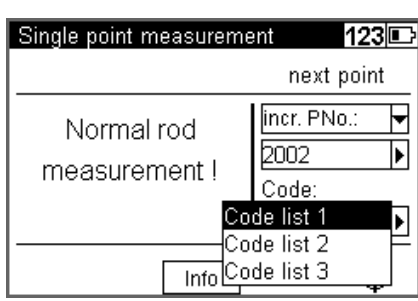
Actions	Screen	Comments
<p>There is a possibility to add a single alpha numeric value or to add codes appropriate to the entered three code lists. It is possible to add code after code.</p>		<p>see Creating or Modifying the Three Code Lists on page 115. The point code has 5 digits.</p>

Alphanumeric Input

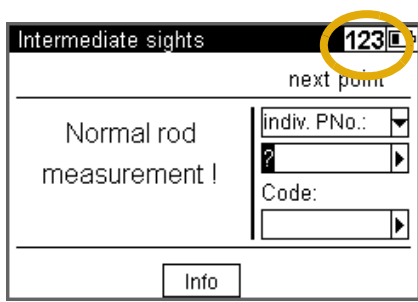
Actions	Screen	Comments
<p>Key in a input line</p>		<p>Status line shows the current font.</p>

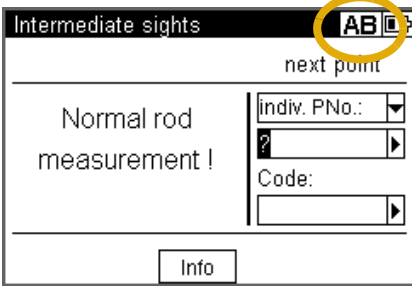
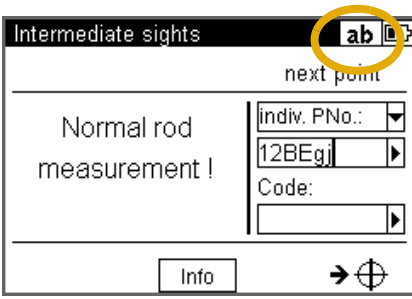
Actions	Screen	Comments
<p>Select with Alpha key the alpha input.</p>		<p>Multiple press on the keys will produce the appropriate character</p>
		<p>Increment will run with the right placed numeric characters only.</p>

Single Point Measurement (Without Reference Height)

This program can be reached with Main menu, Survey and then Single point measurement.

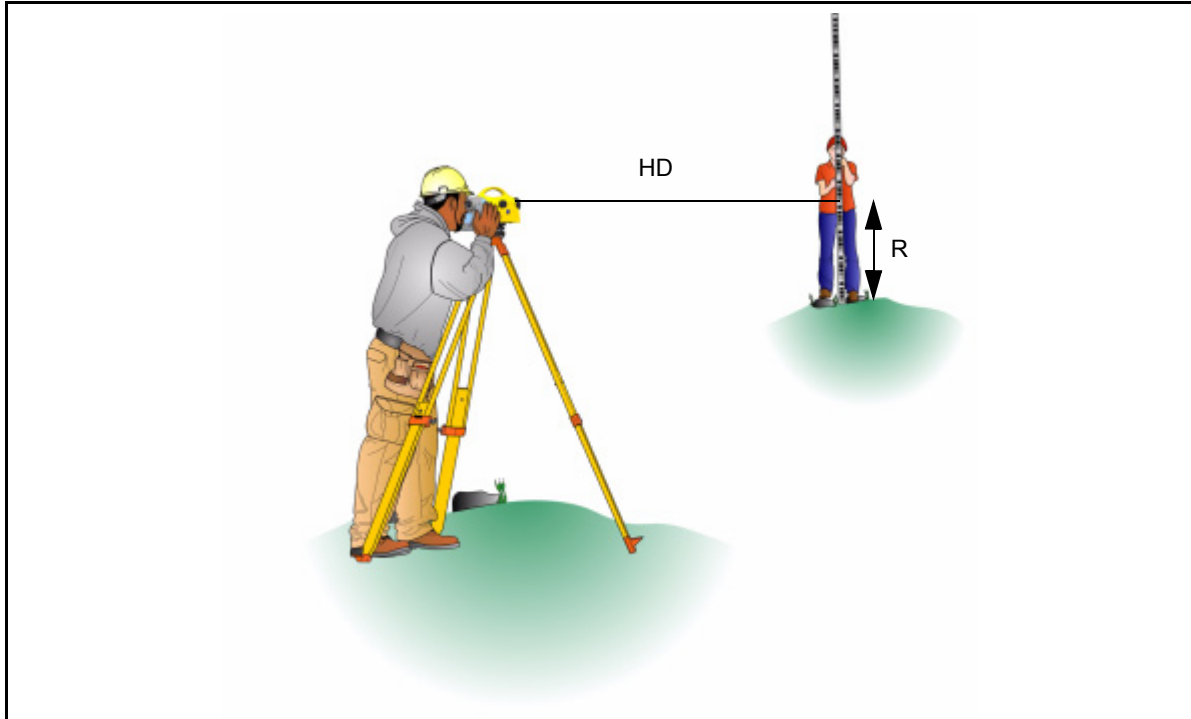



Figure 5.1 Single point measurement (without reference height)

When measuring without reference height, staff readings can be displayed successively and independently of each other. If recording and point number incrementation have been activated, the measurements are stored correspondingly.

Result:

R=Staff reading

HD=Horizontal distance

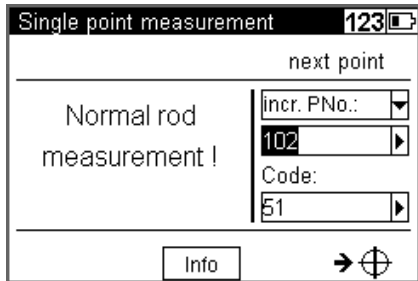
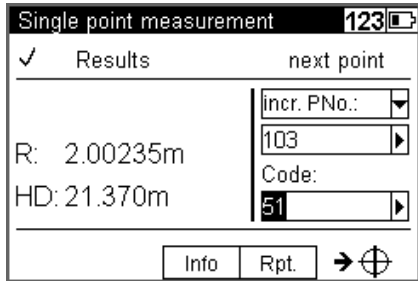
Actions	Screen	Comments
<p>Select Survey and Single Point measurement Enter Point number and Point code. Press the  /  trigger key to start the measurement.</p>		<p>The point number and code entered will be stored with the next measurement.</p>
<p>Start measurement to next point.</p>		<p>Info shows battery status and time, date. Rpt. offers repetition</p>

Line Leveling

The individual height differences are measured and added up. When entering the heights of the start and end points, the nominal - actual difference is computed. Intermediate sights and stake out within the line as well as continuing the line are possible.

Result:

Sh: total height difference

Db,Df: sum of backsight and foresight distances

dz: final difference (if reference heights for start and end points have been entered)

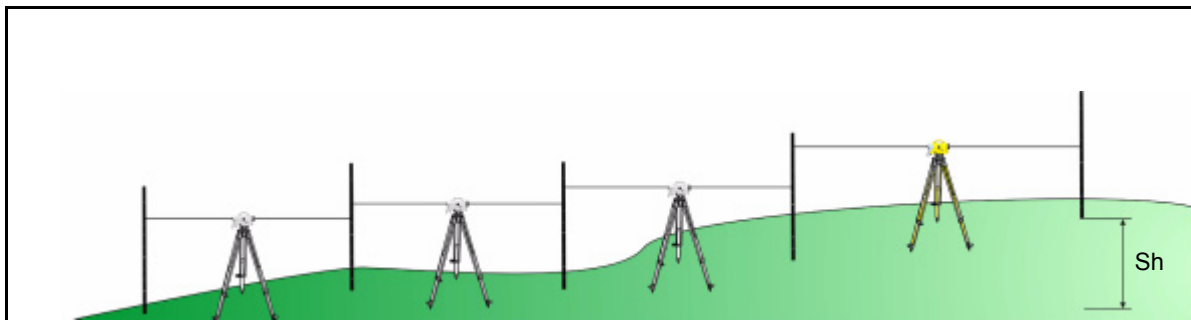

Figure 5.2 Line leveling



Tip – All important settings (point number incrementation, resolution of measured data) are to be made before starting the line measurement. That refers especially to the saving as relevant aspect for the line adjustment option.

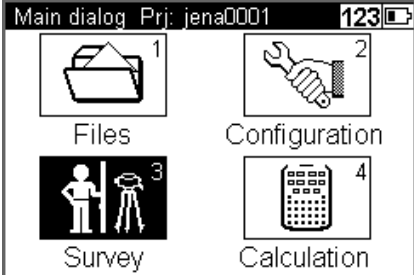
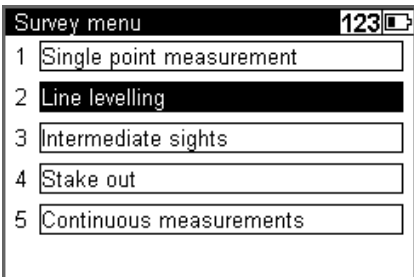
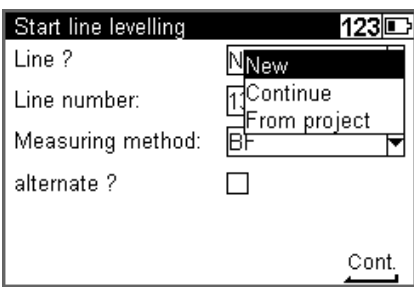

- The DiNi[®] allows a subsequent line adjustment only when measuring in the level mode.
- To ensure a high accuracy, it is possible to monitor adjustable limits and tests e.g. for sighting distance, sighting heights, station differences and the 30cm interval check.

Starting New Line / Continuing Line

Actions	Screen	Comments
Select Survey.		
Select 2 Line leveling.		
Select Line ?		<p>When selecting continue an uncompleted line will be automatically continued.</p> <p>When selecting From project the line number is requested. Each completed line within a project can be continued. A final line adjustment through all data of a line is also possible.</p>



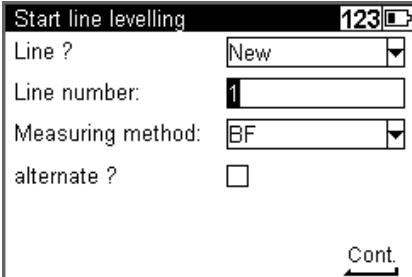
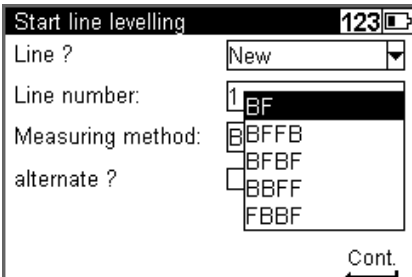

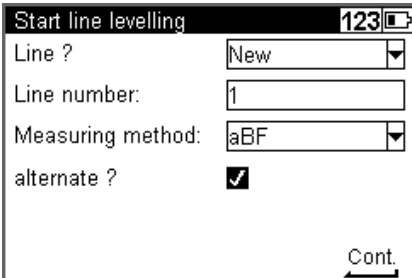
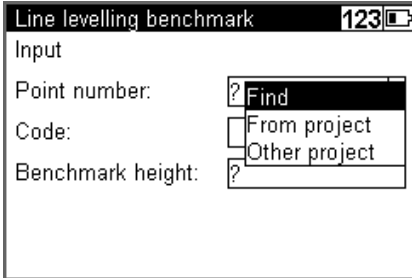
Tip – In order to minimize potential problems in long lines, we recommend to insert now and then fixed change points where the line ends and is continued immediately with the "continue line" option. This operation (line end / continuation) does not affect further line computing, but enables you, in case of a problem, to link the possibly lost line to this point and to connect later the partial lines manually (to add them).

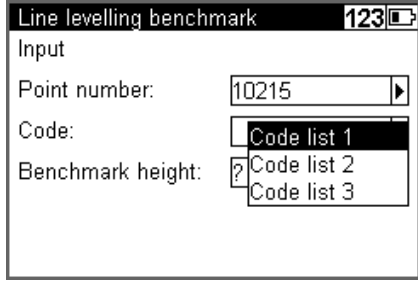
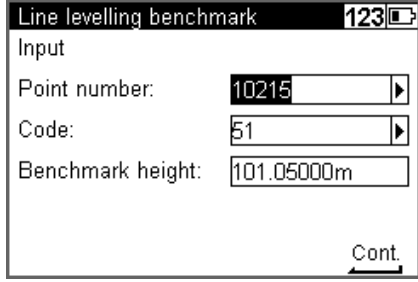
Actions	Screen	Comments
<p>Key in the Line number of your choice.</p>		
<p>Select the Measuring method.</p>		<p>DiNi 0.7/1.3: BF and BFFB DiNi 0.3/1.0: BF, BFFB, FBBF, BFBF, BBFF</p>
<p>Select or deselect alternate. To confirm the inputs on this page and continue to the next page press enter , Cont.</p>		
<p>Select Point number from the drop-down list or key in the point number of your choice.</p>		<p>Select Find to find the next free point number. Select From project to select a point number from the present project. Select Other project to select a point number from another project.</p>

Actions	Screen	Comments
<p>Select Code from the drop-down list or key in the code of your choice.</p>		<p>Select From list to select a code from a code list.</p>
<p>Key in the benchmark height.</p>		<p>If Point number is chosen from a list the benchmark height will be given automatically.</p>

Backsight and Foresight Measurements

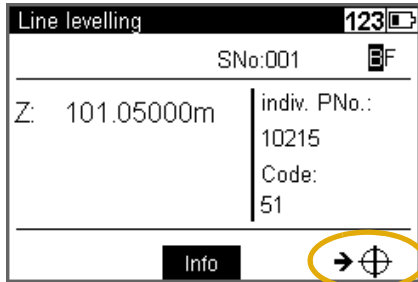
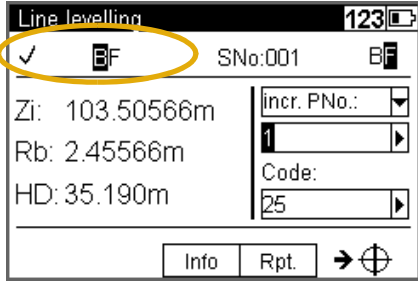

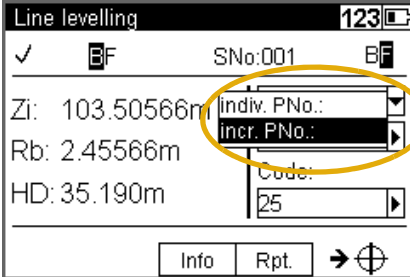
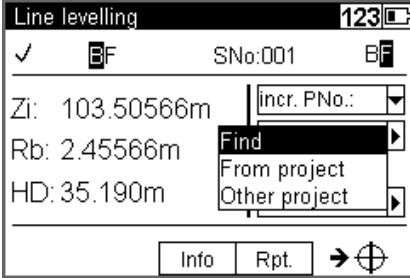
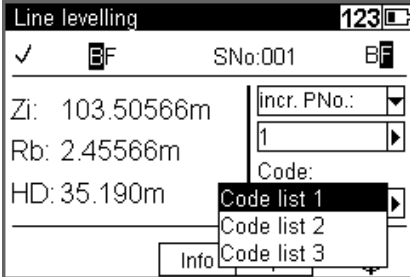

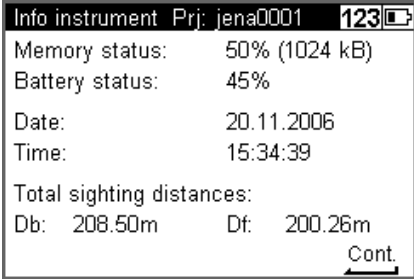
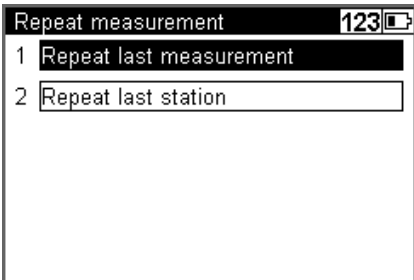
Actions	Screen	Comments
<p>Aim and focus the instrument to the staff. Start a backsight measurement with the  /  trigger key.</p>		<p>The symbol on the right bottom part of the display indicates that the instrument is ready to measure.</p>
<p>When the backsight measurement is ready the result will be displayed</p>		<p>When a measurement is ready it will be marked as done and the number of measurement will increment.</p>

Actions	Screen	Comments
<p>Select incremented or individual point number.</p>		
<p>Select Point number from the drop-down list or key in the point number of your choice.</p>		<p>Select Find to find the next free point number. Select From project to select a point number from the present project. Select Other project to select a point number from another project.</p>
<p>Select Code from the drop-down list or key in the point number of your choice.</p>		<p>Select From list to select a code from a code list.</p>

Actions	Screen	Comments
<p>Select Info.</p> <p>As total sighting distances are known, the next stations have to be selected in such a way that the total sighting distances Db and Df are almost identical at the end of the line.</p>		<p>Additional information Date, Time and Memory status.</p> <p>Db=Distance backsight Df=Distance foresight</p>
<p>Select Rpt. if you wish to repeat the last measurement or the last station</p>		<p>Repeated Data lines will be marked with 5 # and ignored for calculations.</p>

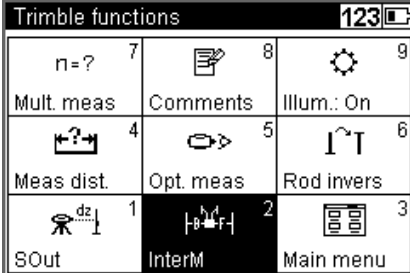
Intermediate Sights in Line Leveling

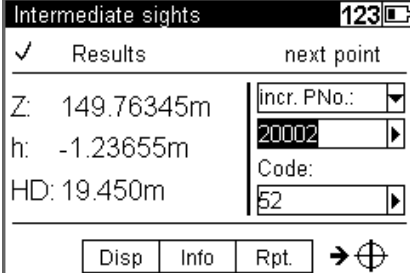

After backsight measurement (Method BF, BBFF) or complete station measurement (all other Methods including alternated versions) are done (reference height available) Intermediate Sights measurements are possible.

Actions	Screen	Comments
Press  Trimble key and Select InteM (2)	 <p>The screenshot shows a grid of 9 menu items: n=? (7), Mult. meas (4), Meas dist. (1), SOut (1), Comments (8), Opt. meas (5), InterM (2), Main menu (3), and Illum.: On (9). The 'InterM' option is highlighted.</p>	
Start the measurement with the  /  trigger key. Press  Escape to return to Line leveling	 <p>The screenshot shows measurement results: Z: 149.76345m, h: -1.23655m, HD: 19.450m. It also includes fields for 'incr. PNo.' (20002) and 'Code' (52). Buttons for 'Disp', 'Info', 'Rpt.', and a directional key are at the bottom.</p>	Start number and Increment works appropriate the settings different to the Line leveling.

Note – The program Line Adjustment will only calculate and improve the Intermediate points in respect to the respective instrument station.

Stake Out in Line Leveling

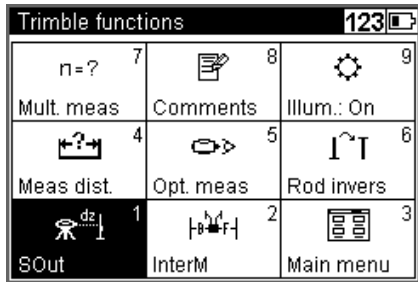

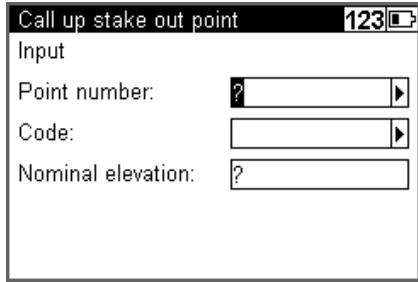
After backsight measurement (Method BF, BBFF) or complete station measurement (all other Methods including alternated versions) are done (reference height available) Stake out measurements are possible.

Actions	Screen	Comments
Press  Trimble key and Select SOut.	 <p>The screenshot shows a grid of menu options: 'n=?' (7), 'Mult. meas' (4), 'Meas dist.' (1), 'SOut' (1), 'Comments' (8), 'Opt. meas' (5), 'InterM' (2), 'Illum.: On' (9), 'Rod invers' (6), and 'Main menu' (3).</p>	
Select Stake Out Point number from this or other projects or key in the point number, code and nominal elevation of your choice. Press  Escape to return to Line leveling	 <p>The screenshot shows an input screen with three fields: 'Point number:', 'Code:', and 'Nominal elevation:', each with a question mark and a right-pointing arrow.</p>	see Stake Out on page 83

Note – The program Line Adjustment will not adjust and change the Stake Out heights.

Selectable and Automatic Controls During Line Leveling

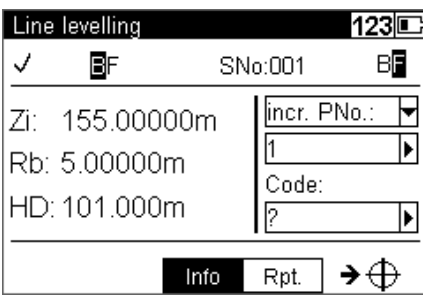
Selectable Controls

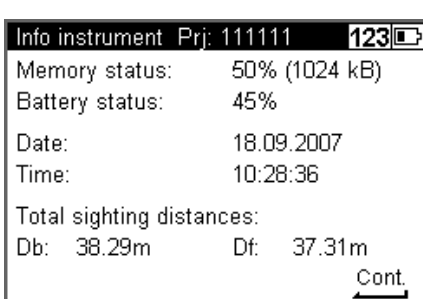
Actions	Screen	Comments
<p>It is possible at every station to see the total sighting distances. Select Info and press  enter key.</p>		
<p>The total sighting distances are displayed as Db and Df. Press  enter key to Continue.</p>		<p>Note – As total sighting distances are known, the next stations have to be selected in such a way that the total sighting distances Db and Df are almost identical at the end of the line.</p>

Automatic Controls

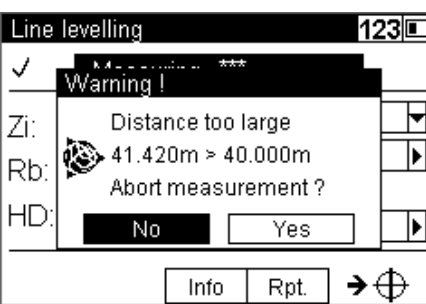
Actions	Screen	Comments
<p>To set up automatic controls see Limits / Tests on page 40</p>		<p>The following automatic controls can be set:</p> <ul style="list-style-type: none"> • Maximum sighting distance • Minimum sighting height • Maximum sighting height • Maximum station difference or double measurement difference(e.g. in BFFB) • Check up for the 30cm interval.
<p>The instrument will warn the user when a measurement is outside the set limits. Press No to accept measurement or Yes to repeat measurement</p>		

Ending a Leveling Line

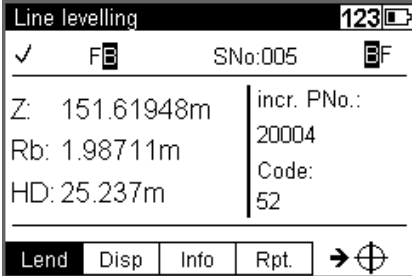
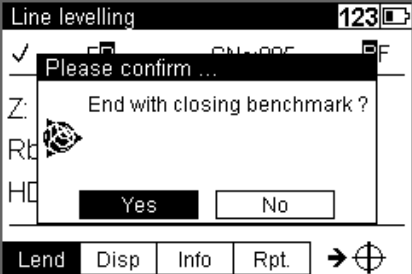
Actions	Screen	Comments
<p>Select End</p>		
<p>Select Yes at a point with a known height. Select No at a point with a unknown height</p>		

With Known Height

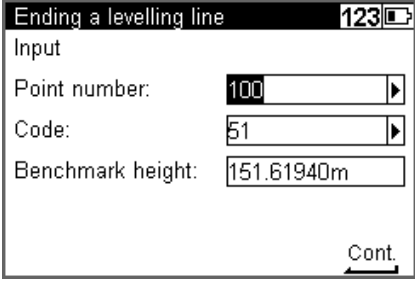
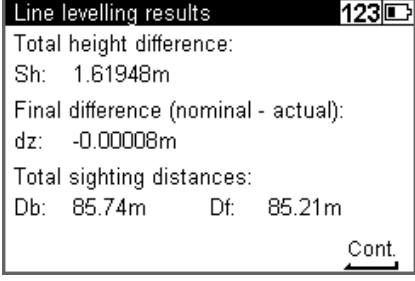
Actions	Screen	Comments
<p>Select:</p> <ul style="list-style-type: none"> enter Point number, Code and Benchmark height from your choice or select from the memory a known point with Point number, Code and Benchmark height. <p>Select Cont. to continue</p>		<p>If at this station the start point number were entered, the program will take all data (height, code) from this point (Slope line).</p>
<p>Select Cont. to finish the line</p>		<p>Results: Sh: total height difference: Db,Df:sum of backsight and foresight distances dz:final difference because entering the benchmark heights.</p>

With Unknown Height

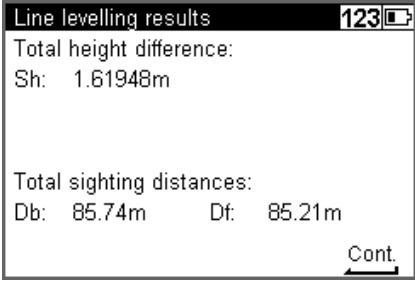
Actions	Screen	Comments
<p>Select Cont. to finish the line</p>		<p>Results: Sh: total height difference Db,Df:sum of backsight and foresight distances</p>

Intermediate Sights

After a backsight measurement of a point with known height, the heights of discretionary points are determined.

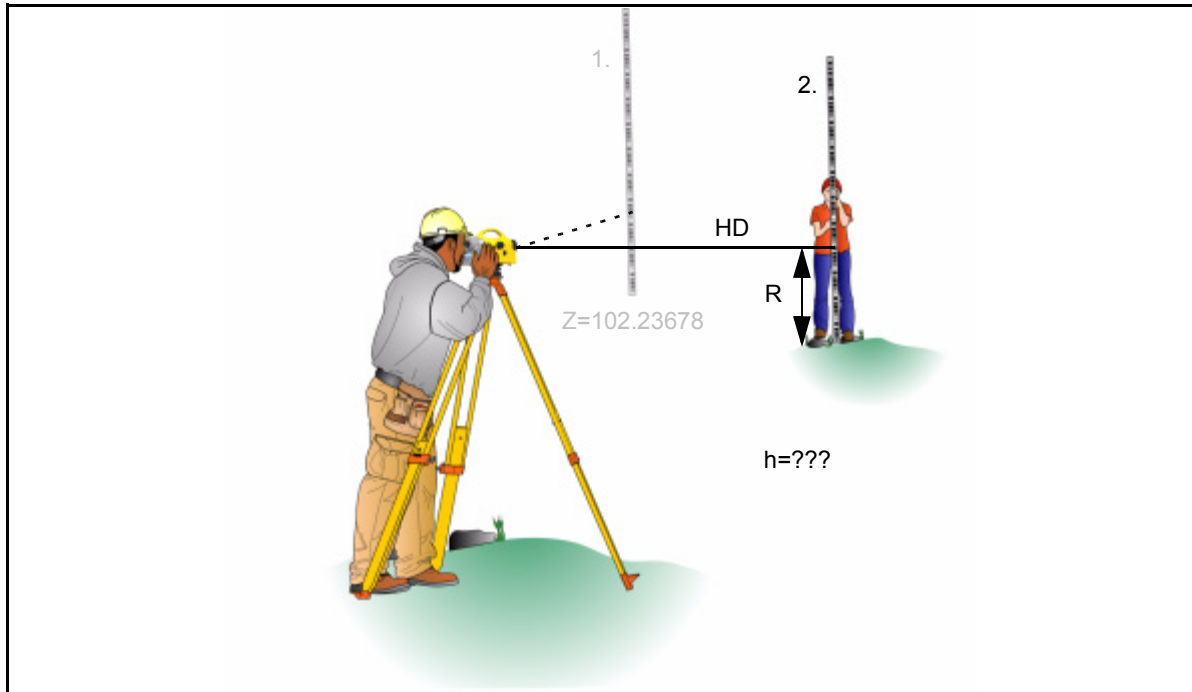
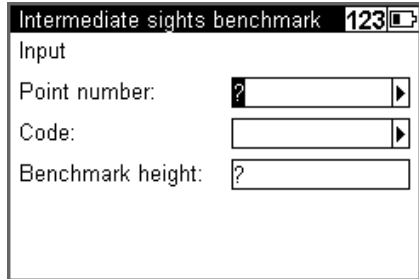
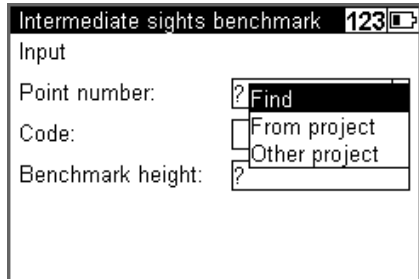

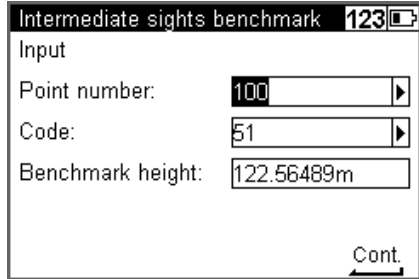

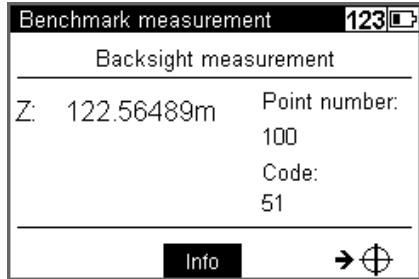

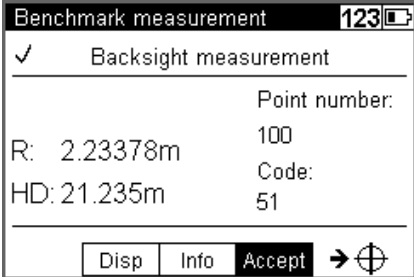

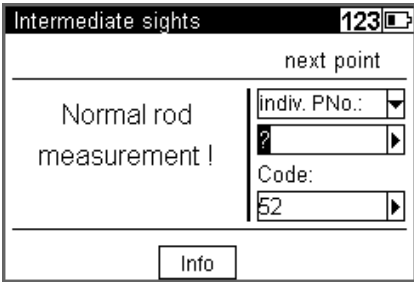

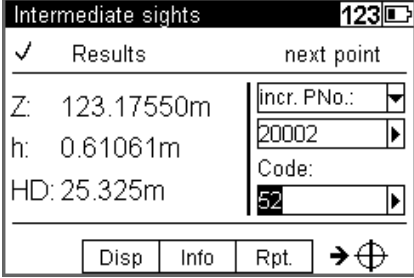



Figure 5.3 Intermediate sights

Result:

Z=Height of intermediate point

h=Height difference between new and backsight point(for display only)

Actions	Screen	Comments
<p>Select Survey and Intermediate Sights</p>		
<p>Select Point number from the drop-down list or key in the benchmark point with number, code and height of your choice.</p>		<p>Select Find to find the next free point number. Select From project to select a point number from the present project. Select Other project to select a point number from another project</p>
<p>Press  enter key to continue.</p>		<p>Selected benchmark points can be modified in number and code.</p>
<p>Aim and focus the instrument to the staff at the benchmark. Start the measurement with the  /  trigger key.</p>		

Actions	Screen	Comments
<p>Accept the measurement to benchmark point or repeat the measurement.</p>		
<p>Key in the point number and code for new point. Start the measurement with the  /  trigger key.</p>		<p>Incr./Indiv: Define the number type PNo: Select Find to find the next free point number. Code: Select from a list</p>
<p>Key in the point number and code for next new point. Start the measurement with the  /  trigger key.</p>		<p>Result of new point Select Disp to change view. Select Rpt. to repeat last measurement</p>
<p>Press  escape key Select Yes and press  enter key to end the program.</p>		

Stake Out

Stake Out

After the measurement of a point with known height, the heights of the points to be staked out (approximate points) and the differences between nominal and actual values are determined. The staff is shifted until the difference measured between the nominal and actual values has been reduced sufficiently.

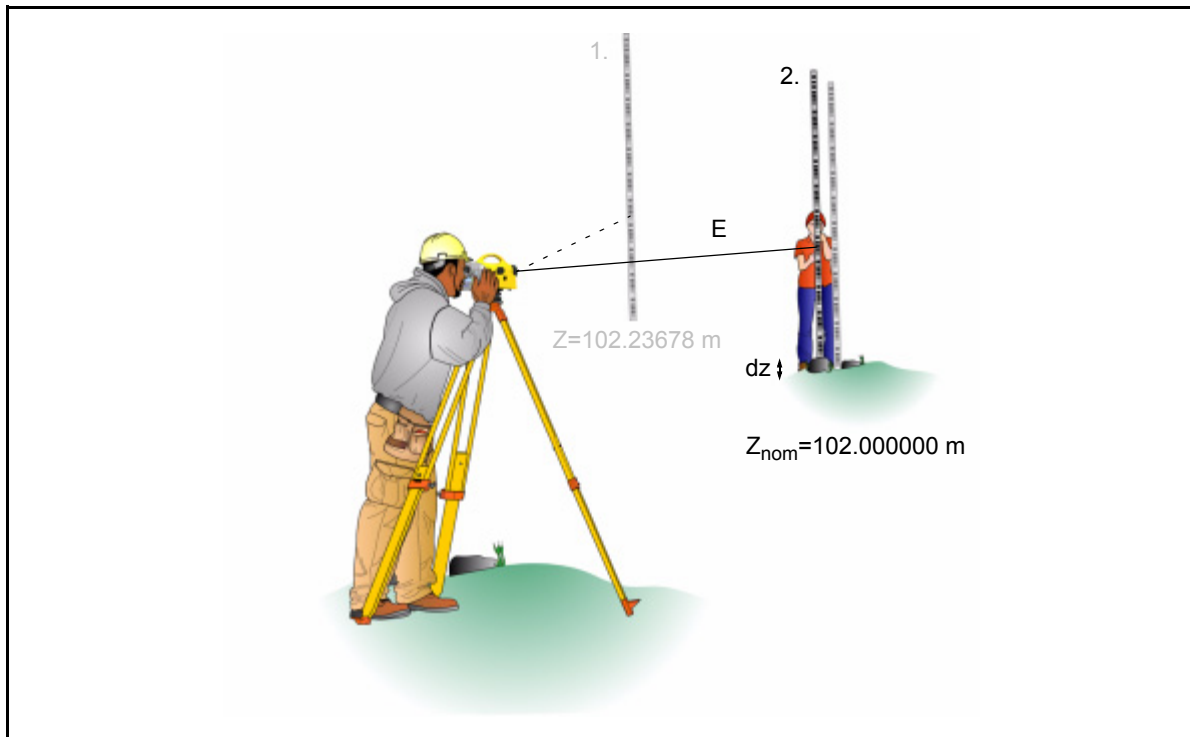
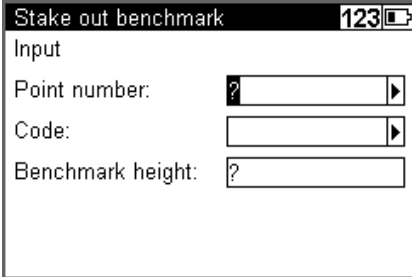
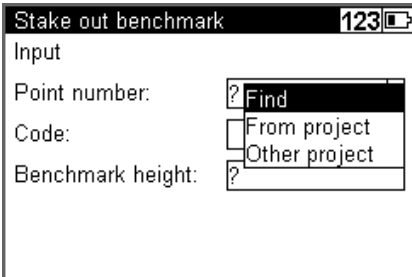

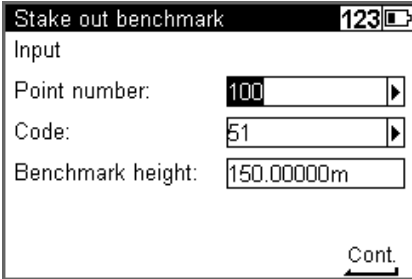

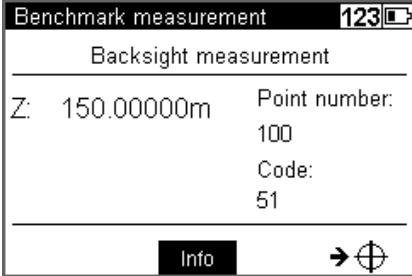
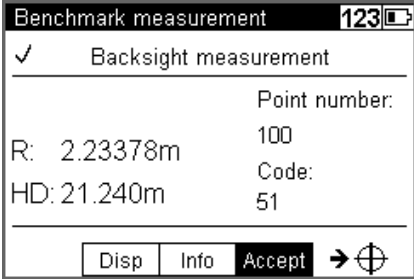
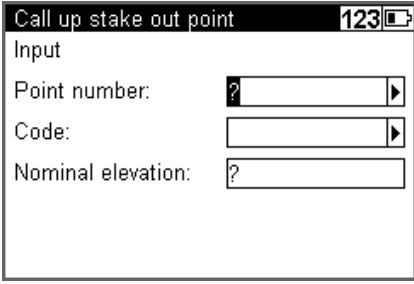
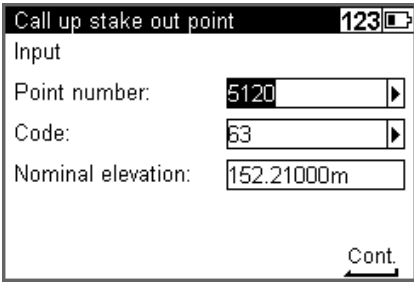

Figure 5.4 Stake out









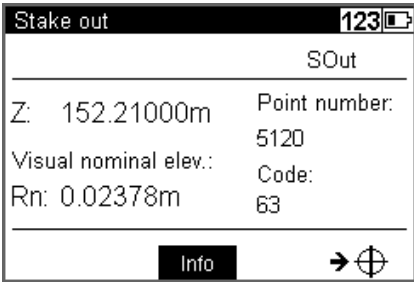

Result:

dz : Setting out difference (nominal - actual)

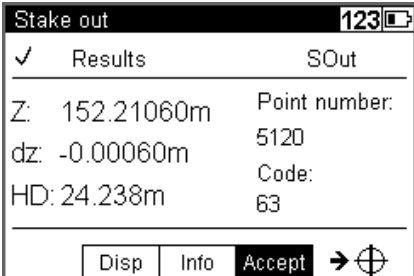
Actions	Screen	Comments
<p>Select Survey and Stake out.</p>		
<p>Select Point number from the drop-down list or key in the benchmark point with Point number, Code and Benchmark height of your choice.</p>		<p>Select Find to find the next free point number. Select From project to select a point number from the present project. Select Other project to select a point number from another project.</p>
<p>Press  enter key to Continue.</p>		<p>Selected benchmark points can be modified in Point number and Code.</p>
<p>Aim and focus the instrument to the staff at the benchmark. Start the measurement with the  /  trigger key.</p>		

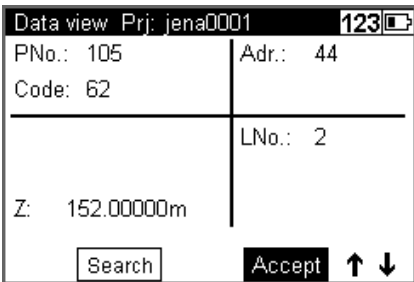







Actions	Screen	Comments
<p>Accept the measurement to benchmark point or repeat the measurement.</p>		
<p>Select Point number from the drop-down list or key in the Point number, Code and Benchmark height for the Stake out point of your choice.</p>		<p>Select Find to find the next free point number. Select From project to select a point number from the present project. Select Other project to select a point number from another project.</p>
<p>Press ↓ enter key to Continue.</p>		<p>Selected Stake out points can be modified in Point number and Code.</p>

Measurement to Digital Graduation of Staff

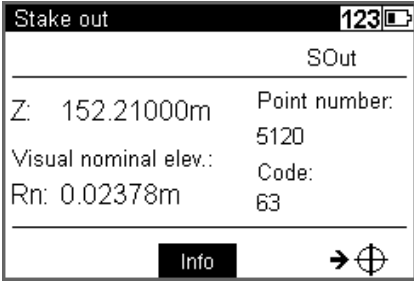
Actions	Screen	Comments
<p>Aim and focus instrument to staff at Stake out point. Start the measurement with the  /  trigger key.</p>		
<p>Select accept and press  enter key to confirm and save the result.</p>		<p>According to the deviation dz, staff will be shifted and measurement repeated until dz has been reduced sufficiently</p>
<p>Select Down arrow and press  enter key to call up the next Stake out point or press  escape key to key in the next Stake out point or use Search to define the next search criteria.</p>		
	<p>Tip – When calling the heights to be staked out from a project in instrument memory, the address of the last height just staked out appears after the result has been confirmed. By pressing  spider key down arrow and Accept this value, the next height to be staked out can be called immediately, provided that the heights have been stored in the desired order in the project. By pressing  escape key it is possible to return to the menu to enter heights and call up search.</p> <p>Tip – With Search a search criteria for the next Stake out point can be defined.</p>	

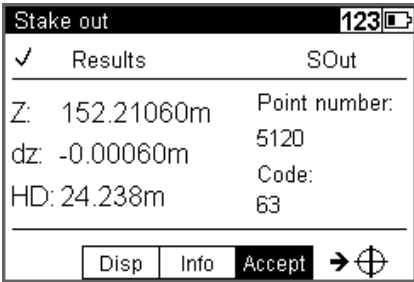
Stake Out With Metrical Graduation of the Staff

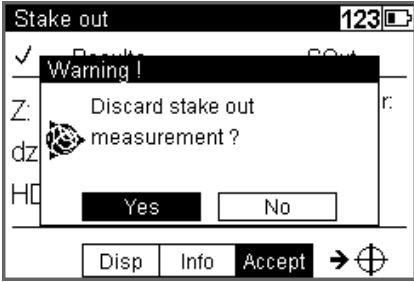
Staff carrier turns staff with metrical graduation towards the observer and receives instruction for height adjustment of staff.

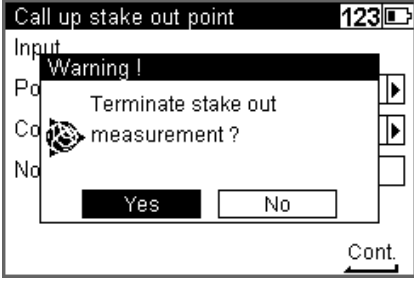
Actions	Screen	Comments
<p>To release the control measurement start a measurement with the  /  trigger key.</p>		<p>staff carrier turns staff with metrical graduation towards the observer and receives instruction for height adjustment of staff. After height adjustment of the staff, carrier turns staff with code graduation to observer.</p>
<p>Select accept and press  enter key to confirm and save the result.</p>		<p>Select Disp to change view</p>
<p>Press  escape key, select Yes and press  enter key to discard the stake out measurement.</p>		
<p>Press  escape key, select Yes and press  enter key to end the stake out measurement.</p>		

Line Adjustment

Line Adjustment (For Instrument Type 0.3mm/km Only)

In line leveling, a line is linked to points with known heights at the beginning and at the end so that the measured height difference can be compared with the nominal height difference.

The "line adjustment" program allows to spread the occurring difference over the individual staff stations proportionally to the sighting distances, obtaining adjusted heights as result. During this operation, the measured values (staff readings, distances) are not changed. Intermediate sights are only improved according to the improvement of the respective instrument station.

Line adjustments can only be performed if the leveling line has been completed and saved on the memory along with the intermediate heights.





It may happen that the definite heights of backsight points are not yet known when the line is measured. In this case, the nominal height values can be entered during the line adjustment. It is also possible to adjust loops. Loops are leveling lines with identical start and end height.

Requirements for a line adjustment:



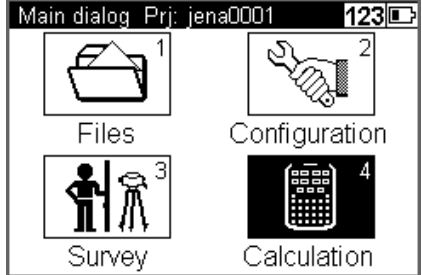

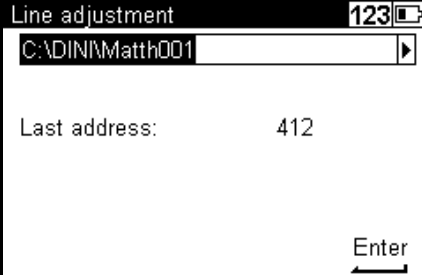
1. The entire leveling line has to be recorded in **one** project.
2. Set in **any case** the recording mode **RMC**.
Otherwise line adjustment will not be possible, as in the project no space is reserved for the adjusted heights.
3. While measuring a station, the leveling line must not be interrupted in such a way that measurements are skipped.
4. The common adjustment of successive partial lines is only possible if they are linked by the "continue line" option.
But they can be positioned in chronological order at different spots in the project. Different partial lines started in each case with "new line" can only be adjusted separately.
5. Line adjustment does not include averaging between fore and back reading.
6. Line adjustment cannot be repeated.
7. Before starting line adjustment, make sure the battery is sufficiently charged.
8. The data stored on memory must not be changed between line measurement and line adjustment.
(Before line adjustment is actually started, the leveling line is checked by recalculating the measured line. The program accepts the following differences between original and recalculated values:

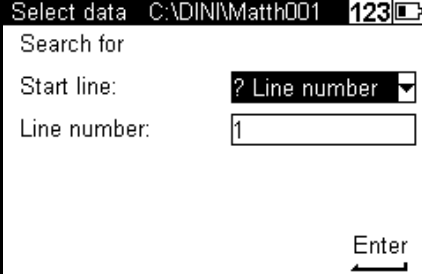
Heights: 0.00002m

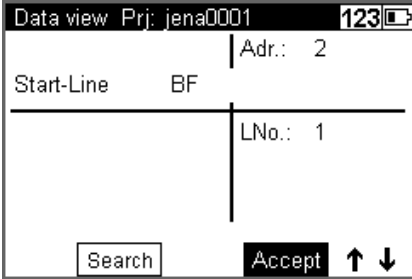
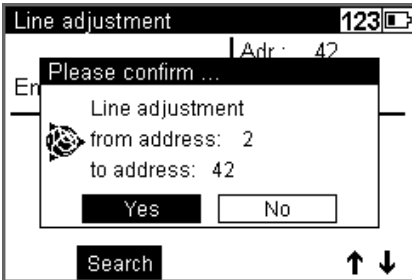
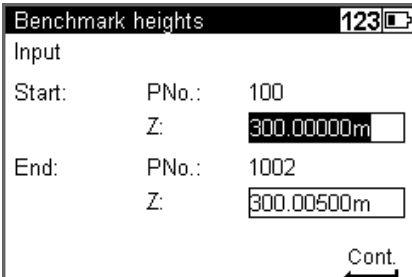
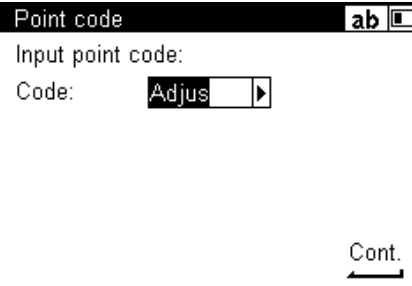
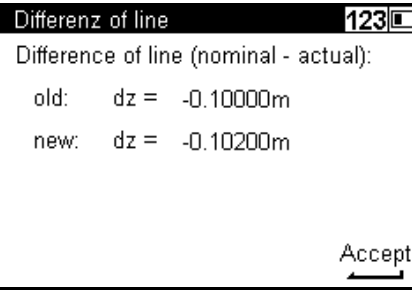
Distances: 0.02m

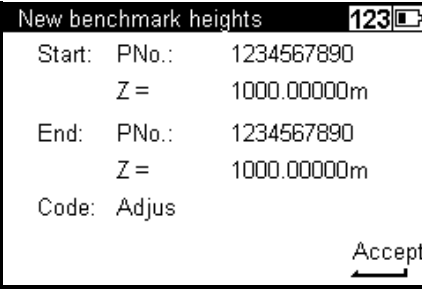
Actions	Screen	Comments
<p>In the Main dialog select Calculation.</p>		
<p>Select Line Adjustment.</p>		
<p>Selected the project to be adjusted and press  enter key to continue.</p>		<p>The program offers the "working" project as default. All lines in all projects are adjustable.</p>
<p>Define the search criteria and enter the value of your choice. Press  enter key to continue.</p>		<p>Search is available with Point number, Point code, Line number and Memory address.</p>

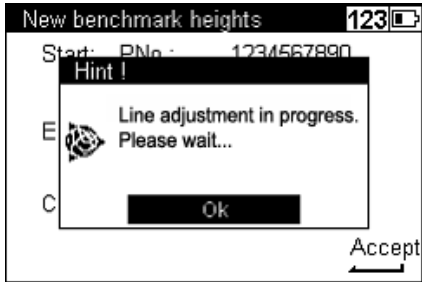
Actions	Screen	Comments
<p>Select Accept and press ↓ enter key to accept the proposed line. Press ↻ spider key up or down arrow to search for lines with the same criteria.</p>		
<p>Select Ok and press ↓ enter key to continue.</p>		<p>The program will find automatically the end of this line and all the continuations. Program will inform about the data lines for the chosen Line.</p>
<p>Key in or confirm the proposed Benchmark heights press ↓ enter key to continue.</p>		
<p>Key in or confirm the proposed Code for the changed Benchmark heights. press ↓ enter key to Continue.</p>		<p>Changed point code helps to identify the changed heights.</p>
<p>Press ↓ enter key to Accept.</p>		<p>Helps to identify human errors in this process</p>

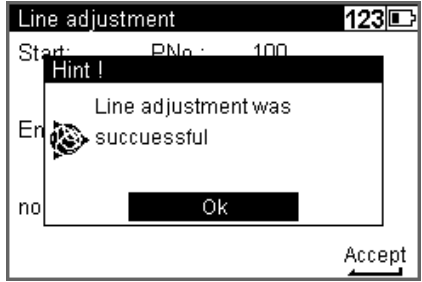
Actions	Screen	Comments
Press  enter key to Accept.		
Press  enter key to continue		<p>Program checks the data lines for changes. With changed data line (heights) the line adjustment is impossible.</p>
Finalize the adjustment by pressing  enter key to End.		

Measuring Function

In this chapter:

- Measuring Principles and Components
- Hints for Precision Measurements

Measuring Principles and Components

DiNi height measurement

The method of single interval measurement is used to determine the height value (comprising a code and interpolation value) on the basis of 15 two-centimetre intervals of the staff and to average the results. For perfect recognition of the intervals and the coded information which they contain, it is essential that the staff image be accurately focused on the instrument cross-hairs.

The usual fluctuations in focusing does not influence the measurement result.

DiNi distance measurement

In the DiNi, the distance to the staff is computed together with the determination of the height. This distance is the horizontal distance between the vertical axis of the instrument and the plane of the graduation of the staff (not the centre of the staff base).

Staff section in the leveling mode

For the determination of heights and distances on the DiNi, the instrument only requires a 30 cm staff section positioned symmetrically to the sighting axis. To ensure optimum measurement results, this staff section must be free from interruptions. Normally this can be easily checked in the eyepiece. For sighting distances of less than 14 m, however, a staff section larger than the visible one is evaluated. If the staff section is interrupted (e.g. by branches) or if measurements are taken beyond the base or top of the staff, the evaluated staff section is no longer symmetrical to the sighting axis.

Since major asymmetries may impair the measuring accuracy, measurement is blocked if obstacles cover more than a few centimetres beyond the cross-hairs (error message: "out of measuring range").

For distances between the minimum sighting distance and a few meters, the instrument only requires a staff section of 10 cm. Due to this minimum measuring section, a range of approx. 6 cm from the beginning and end of the staff is not read for the shortest sighting distance.

Staff code

The staff code consists of 2 cm intervals filled white (yellow) / black or half white (yellow) / half black. For height and distance measurements, only the edges of the 2 cm intervals are used. Thus, necessary controls of invar staves are made easy. The precision code consisting of 1 mm wide lines is only used for decoding purposes in case of sighting distances of less than 6 metres.

Pendulum stop

If the pendulum is at its stop, measurement cannot be started. If the pendulum reaches its stop in the measuring process, the measurement is stopped and error message "compensator out of range" is displayed.

Light conditions

sun

Direct solar irradiation in the telescope must be avoided as this may be harmful to the eye and may cause failure of the measurement. If sun reflections are visible in the telescope (sun low on horizon), shade the telescope with your hand until the reflections disappear. In the case of sun reflections on the staff, turn the staff sideways until the reflections are no longer visible to the observer.

strong light

If measurements are performed against strong light, the measuring time may be increased and the accuracy of the measured data may be reduced.

variation in brightness / overexposure

If variations in brightness during the measuring process lead to overexposure of individual measurements (the sun comes out), the measurement is automatically restarted.

If this situation occurs repeatedly, measurement is stopped with error message "Change in brightness too great".

It can then be started again.

twilight / insufficient illumination

If the measuring signal in twilight is too weak for reliable measurement, if the staff section available is not sufficient for measurement or if no staff has been sighted, error message "Staff cannot be read" is displayed.

If the brightness is just about sufficient for measurement, the measuring time may be markedly increased. Should the resulting measuring times exceed 5 seconds, reduced accuracy of the measured data must be expected. In such cases, it is advisable to illuminate the staff.

staff illumination

If the staff has to be illuminated, we recommend to use a fluorescent lamp installed laterally in front of the staff beside the graduation. If the lamp is placed approximately at the height of the line of sight, a 10 W lamp (12 V, 220 V) will do. Directional light, e.g. by using an accumulator lamp, is not recommendable due to inhomogeneous illumination, formation of shadows or reflexes which could lead to errors of measurement.

Measuring beam interruption

In sunlight, a short interruption of the measuring beam is of virtually no importance, due to the short exposure times. If the measuring beam is interrupted by traffic and measurements are lost, the measuring time will be extended accordingly.

Vibrations

The displayed reading is a mean value obtained from several measurements. In the case of major differences between the individual measured values, the measurement is rejected and error message "Standard deviation out of range" is displayed. This only eliminates gross errors; an assessment of the quality of the measured data is not made. In the case of vibrations or air turbulences, it has been found that the measurements displaying the smallest deviations need not necessarily provide the best measured data.

Multiple Measurement

We recommend to use the multiple measurement option in such cases. Avoid triggering a measurement in moments of strong vibration, e.g. when a heavy vehicle is passing. This can be visually checked.

5 m telescopic staff

DiNi instruments provide measurements with DiNi code staves of up to 5 m length. For this, the 5 m telescopic staff Td 24 and TD 25 are available. For the measurements all staff sections below the measured height value must be slid out and locked. If you take measurements with the staff being pushed in either partially or completely, for example as you do not need the full length of the staff, make sure not to sight at the pushed in section of the staff. Otherwise, erroneous measurements or nonsensical results cannot be precluded.

Hints for Precision Measurements

A digital level is an optical level with automatic data logging, data storage and data processing. For this reason, the marginal conditions to be observed when using a digital level are the same as with an optical level.

Hints for Precision Leveling

- Do not expose tripod and instrument to one-sided irradiation by sun light. Avoid sighting across fields with intense irradiation by sun light, e.g. at noon.
- Take into account that also digital levels require sufficient time to adjust to the ambient temperature. The measurement applies: Temperature difference in Kelvin $\times 2 =$ duration in minutes required for the instrument to adjust to the new temperature. For measurements of normal accuracy, e.g. using foldable staves, at least half the above duration should be considered for temperature adjustment.
- The DiNi instruments are equipped with a temperature sensor. The temperature gradient of the line of sight of the instrument is determined and stored by the factory. The instrument carries out the necessary improvement of the line of sight immediately during the measurement. This correction is only possible in instruments completely adjusted to the ambient temperature and, consequently, does not make the temperature adjustment unnecessary.
- Equal sighting distances shall by all means be kept to eliminate possible variations of the line of sight by temperature, mechanical stress and instrumental effects (focusing lens).
- Do not choose sighting distances that are considerably longer than 30 m.
- To obtain the specified accuracy of the instrument and eliminate the residual compensator error, make sure the circular level has been adjusted well and apply one of the following methods for measuring:
 - a. Measurement according to an alternate method, known as "red trousers" method (BFFB,FBBF)
 - b. Measurement according to a non-alternate method (BFFB,BFFB) after measuring B,F, readjust the circular level with orientation to foresight.
- Before triggering a measurement, make sure that vibrations and shocks transmitted to the instrument e.g. from passing heavy vehicles or strong gusts of wind have settled (check by viewing through telescope or decide by experience).
- Use selectable and automatic controls during Line leveling. These warnings offer the possibility to repeat or use the readings. Under all these circumstances the reading may still be possible, but these tests offer the user the possibility to ensure the highest accuracy in the appropriate application.
 - A warning can be set to avoid measurement to the lowest part of the staff (ground refraction).

- A warning can be set to avoid measurement to the upper part of the staff. This feature is only recommended for highest precision in case of permanent measurement at the upper end of the staff (e.g. in a tunnel).
- A check can be made to ensure that a full 30cm of the staff is visible, equally spaced around the horizontal cross hair. This feature is only recommended for highest precision in case the 30cm section may be partially obscured by obstruction.

Underground, Staff Sinking Into the Ground, Vertical Positioning, Turning

similar to optical levels.

Invar Staves

On request there is a staff certificate, which describes the staves. The staves have to be used, transported and stored properly and to be calibrated in corresponding time intervals.

Hints for Precision Measurement - Area Leveling

For precise area leveling, the adjustment of the line of sight is of great importance due to the different sighting distances. In line leveling, the possible inclination of the horizon is eliminated by equal sighting distances. For precise area leveling, the adjustment of the instrument prior to the measurement is absolutely advisable. In measurements carried out throughout the day, with great temperature differences between the beginning and end of measurements and additionally strong irradiation by sunlight, the internal temperature correction system of the instrument eliminates the main part of the variations of the line of sight. But to make sure, comparison measurements to fixed points should be made and readjustments should be carried out in between, if necessary.

Data Management

In this chapter:

- Data Management
- Project Management
- Editor
- Data Transfer
- Memory
- Data Format
- Recording Data and Data Lines With DiNi

Data Management

DiNi offers a project (files) oriented data storage. Data are stored physically in the internal memory in an internal data format. The data can be transferred directly via Cable to PC or to a USB Memory Stick. During transfer of the data the format will be changed to the common ASCII format M5, thus backwards compatible to the former DiNi Series is guaranteed. The exported project will have the unit of measurement in relation to the current setting (Configuration, Instrument settings Height unit). This allows exporting the file in different units of measurement appropriate to the users chooses.

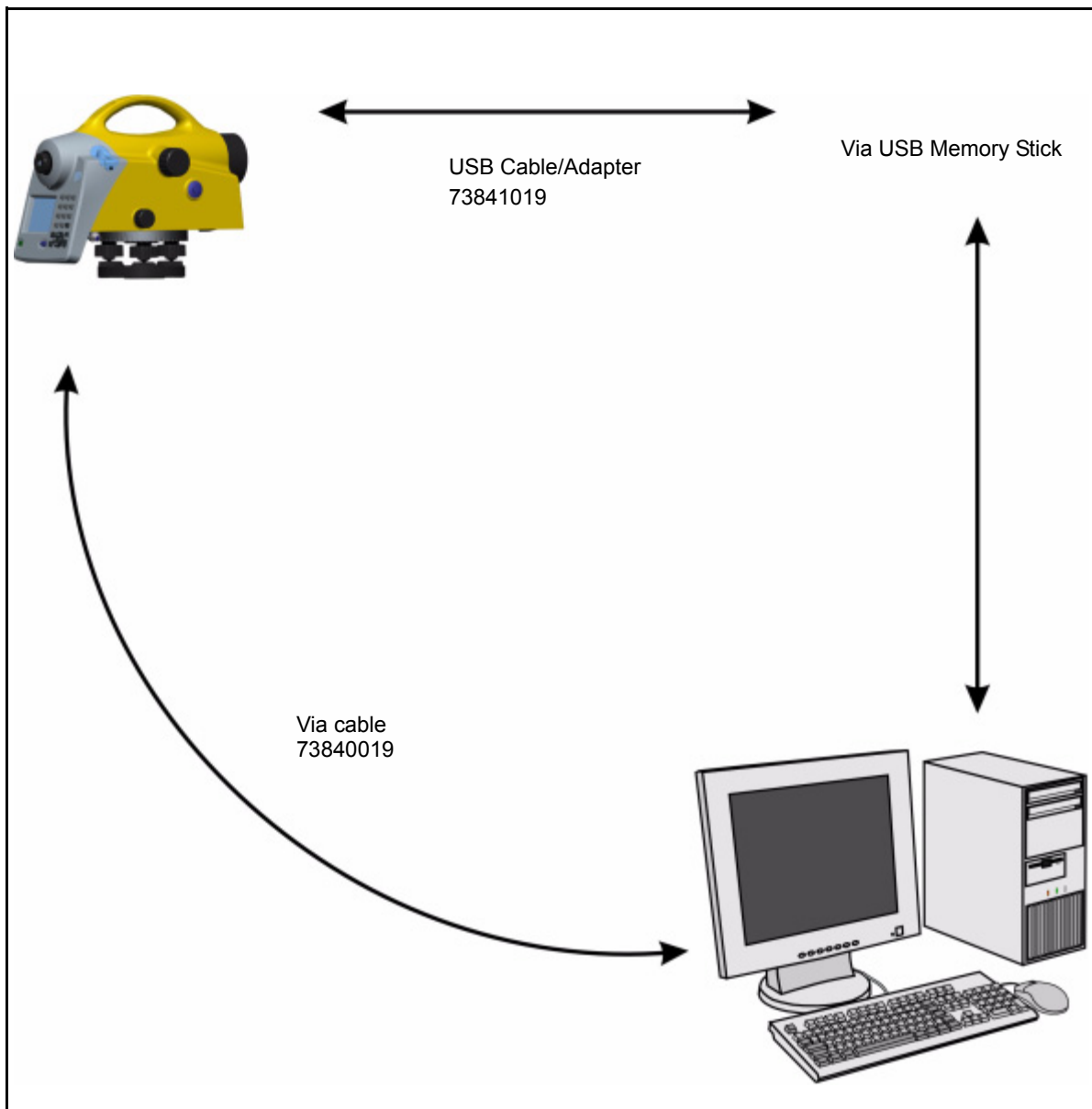
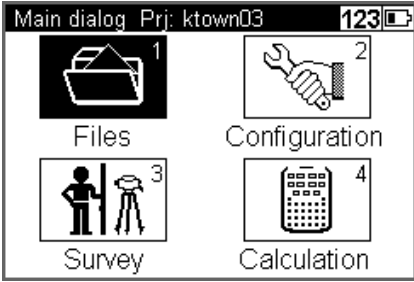
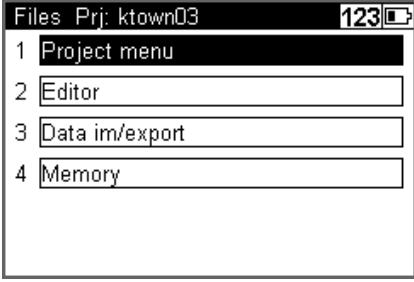

Figure 7.1 Data management

Project Management



The submenu allows select, create, delete and rename projects. Additionally the content from a complete project can be copied in another project.

Actions	Screen	Comments
In the Main dialog select Files.	 <p>The screenshot shows a window titled 'Main dialog Prj: ktown03' with a battery icon and the number '123'. It contains four menu items arranged in a 2x2 grid: 'Files' with a folder icon (labeled 1), 'Configuration' with a wrench and screwdriver icon (labeled 2), 'Survey' with a person and tripod icon (labeled 3), and 'Calculation' with a calculator icon (labeled 4).</p>	
Select Project menu.	 <p>The screenshot shows a window titled 'Files Prj: ktown03' with a battery icon and the number '123'. It displays a list of four menu items: 'Project menu' (labeled 1), 'Editor' (labeled 2), 'Data im/export' (labeled 3), and 'Memory' (labeled 4).</p>	

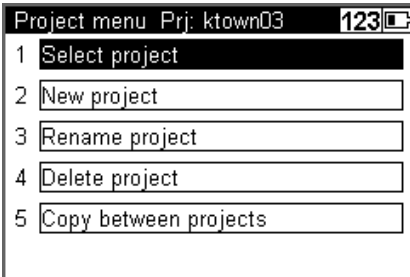
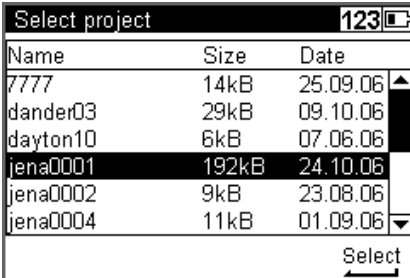
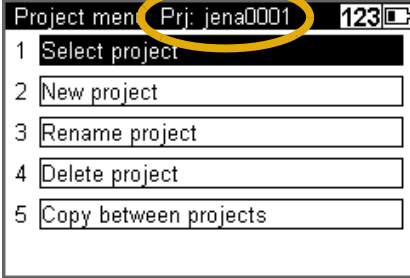
Select a Project

Actions	Screen	Comments																					
Select Select project (1)																							
<p>Highlight the requested project from the project list and press ↓ enter key to select.</p>	 <table border="1" data-bbox="683 745 1094 1021"> <thead> <tr> <th>Name</th> <th>Size</th> <th>Date</th> </tr> </thead> <tbody> <tr> <td>7777</td> <td>14kB</td> <td>25.09.06</td> </tr> <tr> <td>dander03</td> <td>29kB</td> <td>09.10.06</td> </tr> <tr> <td>dayton10</td> <td>6kB</td> <td>07.06.06</td> </tr> <tr> <td>jena0001</td> <td>192kB</td> <td>24.10.06</td> </tr> <tr> <td>jena0002</td> <td>9kB</td> <td>23.08.06</td> </tr> <tr> <td>jena0004</td> <td>11kB</td> <td>01.09.06</td> </tr> </tbody> </table>	Name	Size	Date	7777	14kB	25.09.06	dander03	29kB	09.10.06	dayton10	6kB	07.06.06	jena0001	192kB	24.10.06	jena0002	9kB	23.08.06	jena0004	11kB	01.09.06	<p>All projects are available in the chronological order they were created.</p>
Name	Size	Date																					
7777	14kB	25.09.06																					
dander03	29kB	09.10.06																					
dayton10	6kB	07.06.06																					
jena0001	192kB	24.10.06																					
jena0002	9kB	23.08.06																					
jena0004	11kB	01.09.06																					
		<p>Selected project will be displayed in Main Menu and most of the surveying menus</p>																					

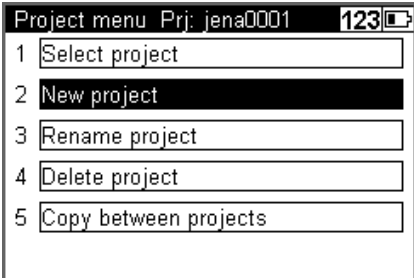
Create a Project

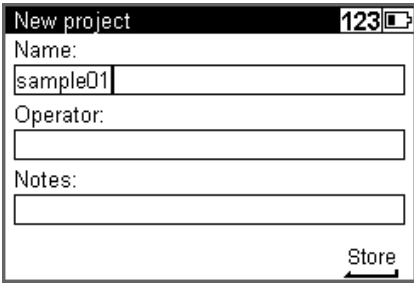
Actions	Screen	Comments
<p>Select New project.</p>		
<p>Key in the project Name of your choice. You can also key in the Operator name and Notes. Press  enter key to Store the project. The project can now be selected from the project list</p>		<p>Input fields are open for alpha and numeric inputs. Name field is limited to 8 character (software compatibility to older versions)</p>

Rename a Project

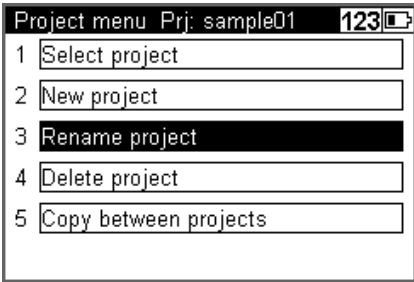
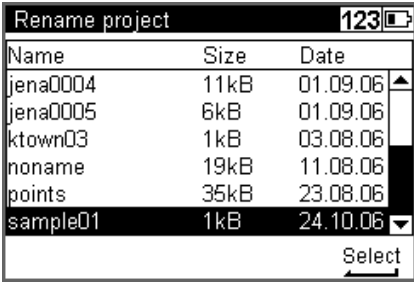
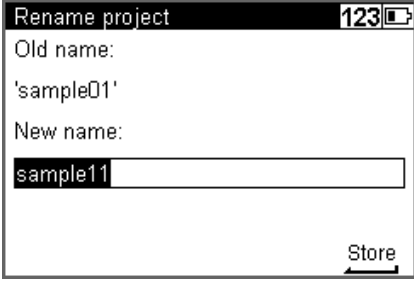
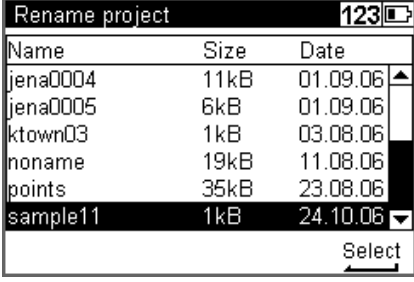
Actions	Screen	Comments																					
Select Rename project.	 <p>Project menu Prj: sample01 123</p> <ul style="list-style-type: none"> 1 Select project 2 New project 3 Rename project 4 Delete project 5 Copy between projects 																						
Select the requested project and press ↓ enter key to Select.	 <p>Rename project 123</p> <table border="1"> <thead> <tr> <th>Name</th> <th>Size</th> <th>Date</th> </tr> </thead> <tbody> <tr> <td>jena0004</td> <td>11kB</td> <td>01.09.06</td> </tr> <tr> <td>jena0005</td> <td>6kB</td> <td>01.09.06</td> </tr> <tr> <td>ktown03</td> <td>1kB</td> <td>03.08.06</td> </tr> <tr> <td>noname</td> <td>19kB</td> <td>11.08.06</td> </tr> <tr> <td>points</td> <td>35kB</td> <td>23.08.06</td> </tr> <tr> <td>sample01</td> <td>1kB</td> <td>24.10.06</td> </tr> </tbody> </table> <p>Select</p>	Name	Size	Date	jena0004	11kB	01.09.06	jena0005	6kB	01.09.06	ktown03	1kB	03.08.06	noname	19kB	11.08.06	points	35kB	23.08.06	sample01	1kB	24.10.06	All projects are available in the chronological order they were created.
Name	Size	Date																					
jena0004	11kB	01.09.06																					
jena0005	6kB	01.09.06																					
ktown03	1kB	03.08.06																					
noname	19kB	11.08.06																					
points	35kB	23.08.06																					
sample01	1kB	24.10.06																					
Key in the new project name and press ↓ enter key to Store.	 <p>Rename project 123</p> <p>Old name: 'sample01'</p> <p>New name: sample11</p> <p>Store</p>	Input field are open for alpha and numeric inputs																					
Press Esc escape key to return to the project menu.	 <p>Rename project 123</p> <table border="1"> <thead> <tr> <th>Name</th> <th>Size</th> <th>Date</th> </tr> </thead> <tbody> <tr> <td>jena0004</td> <td>11kB</td> <td>01.09.06</td> </tr> <tr> <td>jena0005</td> <td>6kB</td> <td>01.09.06</td> </tr> <tr> <td>ktown03</td> <td>1kB</td> <td>03.08.06</td> </tr> <tr> <td>noname</td> <td>19kB</td> <td>11.08.06</td> </tr> <tr> <td>points</td> <td>35kB</td> <td>23.08.06</td> </tr> <tr> <td>sample11</td> <td>1kB</td> <td>24.10.06</td> </tr> </tbody> </table> <p>Select</p>	Name	Size	Date	jena0004	11kB	01.09.06	jena0005	6kB	01.09.06	ktown03	1kB	03.08.06	noname	19kB	11.08.06	points	35kB	23.08.06	sample11	1kB	24.10.06	The change will be shown in the project list.
Name	Size	Date																					
jena0004	11kB	01.09.06																					
jena0005	6kB	01.09.06																					
ktown03	1kB	03.08.06																					
noname	19kB	11.08.06																					
points	35kB	23.08.06																					
sample11	1kB	24.10.06																					

Delete a Project

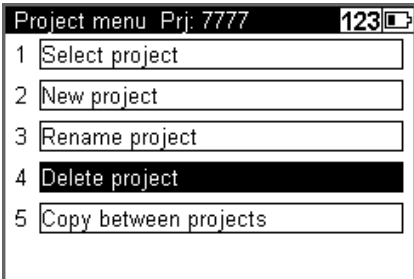
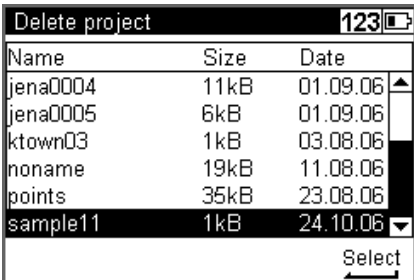
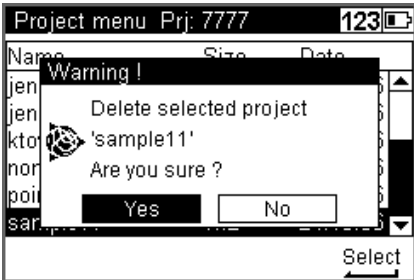
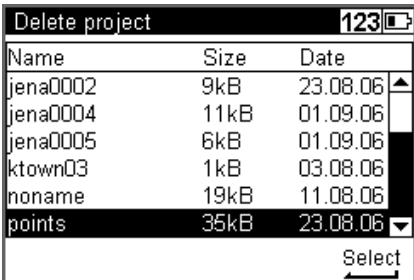
Actions	Screen	Comments
Select Delete project.		
Highlight the requested project and press ↓ enter key to Select.		All projects available in order of created time.
Select Yes and press ↓ enter key to delete the selected project. Select No and press ↓ enter key to escape.		
Select next project to be deleted or press Esc escape key to return to the project menu.		

Copy Between Projects

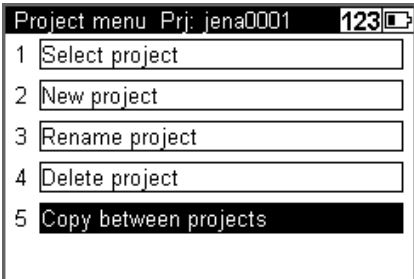
Actions	Screen	Comments																				
Select Copy between projects.																						
Highlight the source project and press ↓ enter key to select.	<thead> <tr> <th>Name</th> <th>Size</th> <th>Date</th> </tr> </thead> <tbody> <tr> <td>jim2</td> <td>8kB</td> <td>17.11.06</td> </tr> <tr> <td>ktown03</td> <td>208kB</td> <td>29.11.06</td> </tr> <tr> <td>line0002</td> <td>3kB</td> <td>08.11.06</td> </tr> <tr> <td>line001</td> <td>22kB</td> <td>08.11.06</td> </tr> <tr> <td>noname</td> <td>19kB</td> <td>11.08.06</td> </tr> <tr> <td>points</td> <td>35kB</td> <td>24.10.06</td> </tr> </tbody>	Name	Size	Date	jim2	8kB	17.11.06	ktown03	208kB	29.11.06	line0002	3kB	08.11.06	line001	22kB	08.11.06	noname	19kB	11.08.06	points	35kB	24.10.06
Name	Size	Date																				
jim2	8kB	17.11.06																				
ktown03	208kB	29.11.06																				
line0002	3kB	08.11.06																				
line001	22kB	08.11.06																				
noname	19kB	11.08.06																				
points	35kB	24.10.06																				

 A 'Select' button is at the bottom right." data-bbox="428 332 688 456"/>

 || All Data lines will be transferred between Data line 1 and Data line 2. | | |
| Before final accepting the data line will be shown in the Editor screen, the selection can be still changed. Same procedure for the Data Line 2 | | |

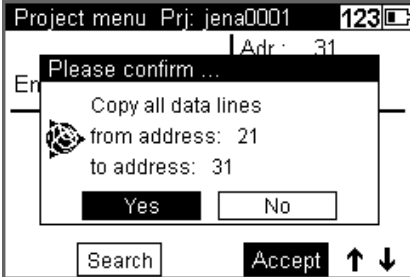
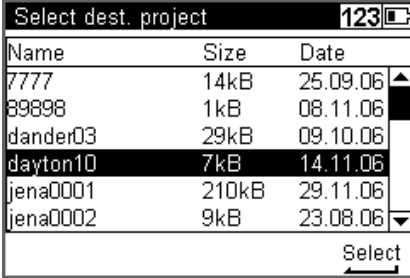
Actions	Screen	Comments																					
<p>Select Yes to confirm or No to escape.</p> <p>Confirm the selection from line to line</p>																							
<p>Highlight the destination project and press ↓ enter key to select</p>	 <table border="1" data-bbox="683 633 1094 909"> <thead> <tr> <th>Name</th> <th>Size</th> <th>Date</th> </tr> </thead> <tbody> <tr> <td>7777</td> <td>14kB</td> <td>25.09.06</td> </tr> <tr> <td>89898</td> <td>1kB</td> <td>08.11.06</td> </tr> <tr> <td>dander03</td> <td>29kB</td> <td>09.10.06</td> </tr> <tr> <td>dayton10</td> <td>7kB</td> <td>14.11.06</td> </tr> <tr> <td>jena0001</td> <td>210kB</td> <td>29.11.06</td> </tr> <tr> <td>jena0002</td> <td>9kB</td> <td>23.08.06</td> </tr> </tbody> </table>	Name	Size	Date	7777	14kB	25.09.06	89898	1kB	08.11.06	dander03	29kB	09.10.06	dayton10	7kB	14.11.06	jena0001	210kB	29.11.06	jena0002	9kB	23.08.06	<p>The process will then run without any user activities</p>
Name	Size	Date																					
7777	14kB	25.09.06																					
89898	1kB	08.11.06																					
dander03	29kB	09.10.06																					
dayton10	7kB	14.11.06																					
jena0001	210kB	29.11.06																					
jena0002	9kB	23.08.06																					

Editor

The Editor allows searching data lines for viewing and changing, input data lines (Height, Point number and Code), delete data lines and creating or modifying the three code lists

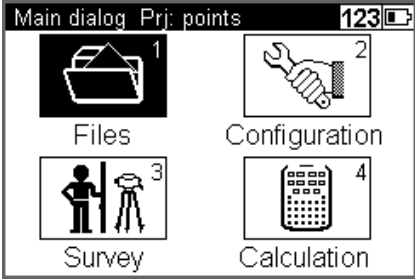
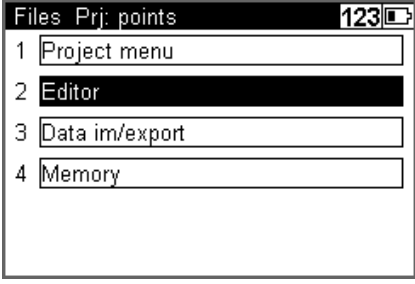
Actions	Screen	Comments
In the Main dialog Select Files.	 <p>The screenshot shows a window titled 'Main dialog Prj: points' with a status bar '123'. It contains four icons with numbers: 1. Files (folder icon), 2. Configuration (wrench icon), 3. Survey (person with tripod icon), and 4. Calculation (calculator icon).</p>	
Select Editor.	 <p>The screenshot shows a window titled 'Files Prj: points' with a status bar '123'. It contains a list of four items: 1. Project menu, 2. Editor (highlighted in black), 3. Data im/export, and 4. Memory.</p>	

Searching Data Lines

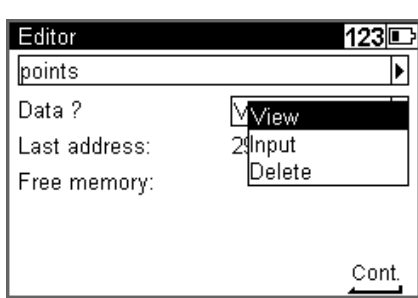
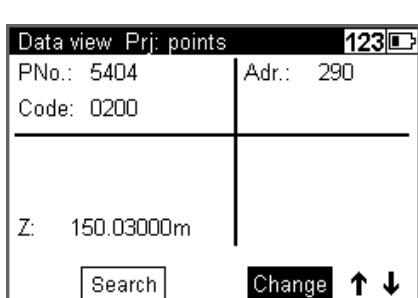
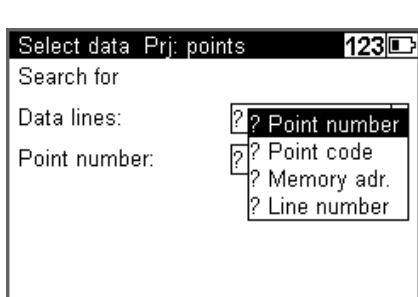

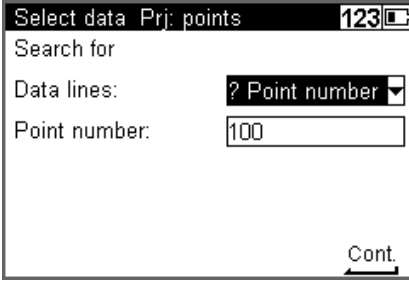
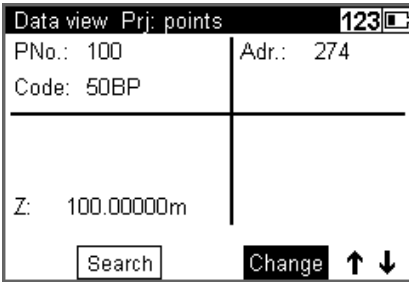
Actions	Screen	Comments
<p>Select Data? from the drop down list. Select View and press ↓ enter key to Continue.</p>		
<p>Select Search and press ↓ enter key to Continue.</p>		<p>The last data line of the project will be shown.</p>
<p>Select Data lines from the drop down list. Select Point number, Point code, Memory address or Line number. Press ↓ enter key to Continue.</p>		

Actions	Screen	Comments
<p>Key in the Point number press ↓ enter key to Continue.</p>		
<p>Press ⬆ spider key up or down arrow to search for lines with identical criteria. Select Change to change Heights, Point numbers and Codes</p>		<p>The program will not allow changing of the measurement values!</p>

Deleting Data Lines

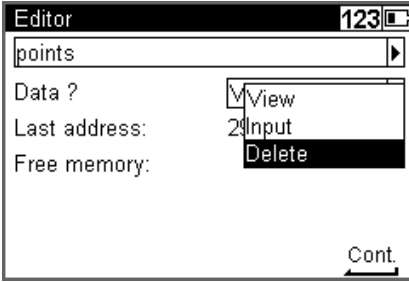

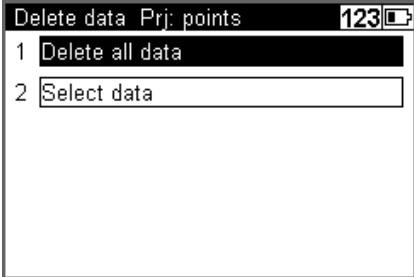

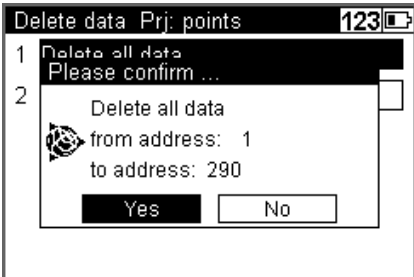

Delete all Data

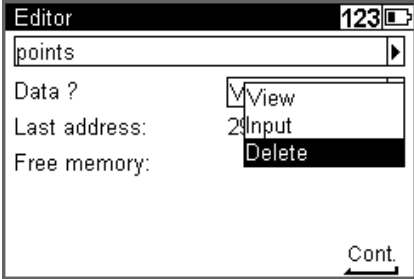
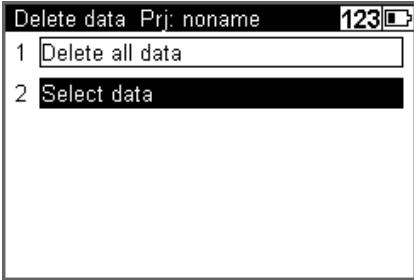
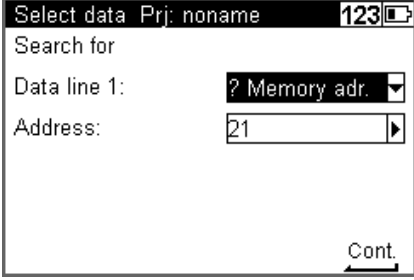
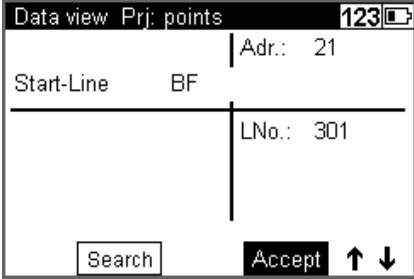
Actions	Screen	Comments
<p>Select Data? from the drop down list. Select Delete and press ↓ enter key to Continue.</p>		

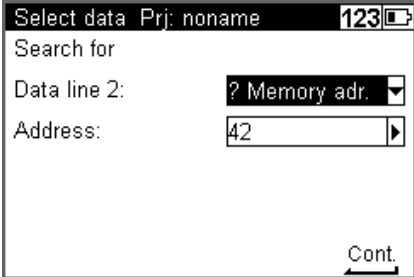

Actions	Screen	Comments
Select Delete all data.		
Select Yes and press  enter key to delete all data in the address range.		

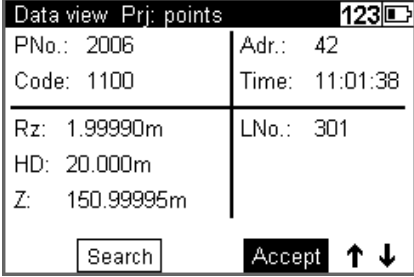
Deleting Selected Data Lines

Actions	Screen	Comments
<p>Select Data? from the drop down list. Select Delete and press ↓ enter key to Continue.</p>	 <p>The screenshot shows the 'Editor' screen with the title bar 'Editor' and a window icon '123'. The main content area has a text field containing 'points'. Below it, there are three labels: 'Data?', 'Last address:', and 'Free memory:'. A dropdown menu is open over the 'Data?' label, showing three options: 'View', 'Input', and 'Delete'. The 'Delete' option is highlighted. At the bottom right, there is a 'Cont.' button with a right-pointing arrow.</p>	
<p>Select Select data.</p>	 <p>The screenshot shows the 'Delete data' screen with the title bar 'Delete data Prj: noname' and a window icon '123'. The main content area has a list with two items: '1 Delete all data' and '2 Select data'. The '2 Select data' item is highlighted with a black background. At the bottom right, there is a 'Cont.' button with a right-pointing arrow.</p>	
<p>Select search criteria from Data line 1 drop down list press ↓ enter key to confirm. Key in the Address and press ↓ enter key to confirm. Press ↓ enter key to Continue.</p>	 <p>The screenshot shows the 'Select data' screen with the title bar 'Select data Prj: noname' and a window icon '123'. The main content area has three labels: 'Search for', 'Data line 1:', and 'Address:'. The 'Data line 1:' label has a dropdown menu showing '? Memory adr.'. The 'Address:' label has a text field containing '21'. At the bottom right, there is a 'Cont.' button with a right-pointing arrow.</p>	
<p>Select Accept and press ↓ enter key to confirm.</p>	 <p>The screenshot shows the 'Data view' screen with the title bar 'Data view Prj: points' and a window icon '123'. The main content area has a table with two columns: 'Start-Line' and 'BF'. The first row shows 'Start-Line' as 'BF' and 'BF' as '21'. The second row shows 'Start-Line' as 'BF' and 'BF' as '301'. At the bottom, there are two buttons: 'Search' and 'Accept', and two arrows: an up arrow and a down arrow.</p>	



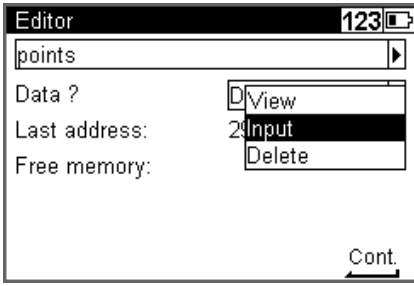

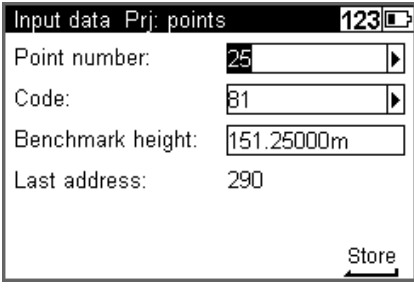

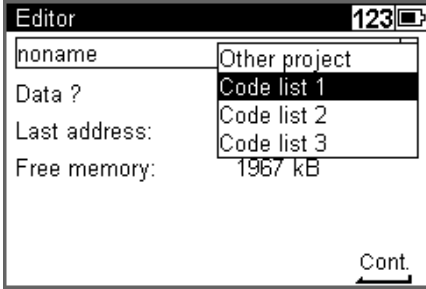
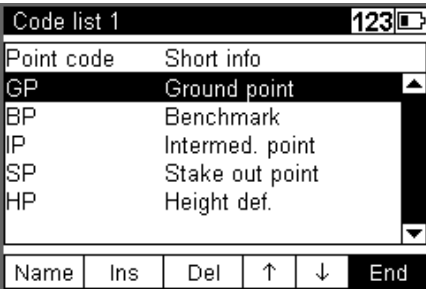
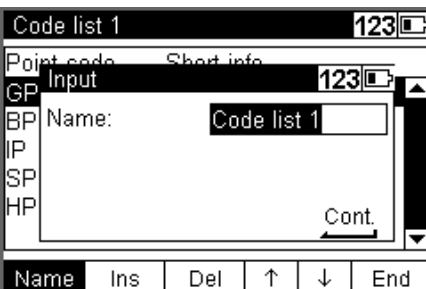
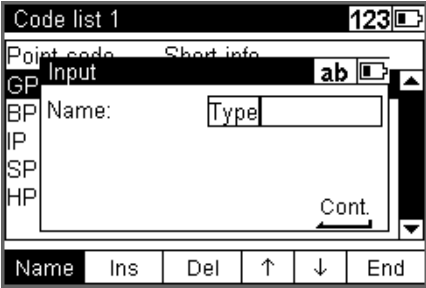

Actions	Screen	Comments
<p>Select search criteria from Data line 2 drop down list press  enter key to confirm.</p> <p>Key in the Address and press  enter key to confirm.</p> <p>Press  enter key to Continue.</p>		
<p>Select Accept and press  enter key to confirm.</p>		
<p>Select Yes and press  enter key to confirm.</p>		<p>Note – All data from address 21 to 42 will be deleted.</p>

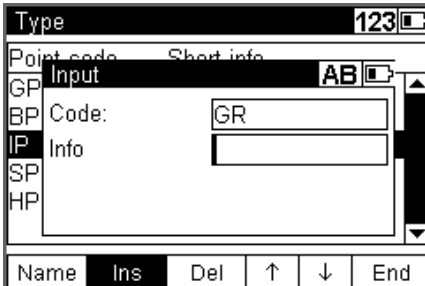
Input of Data Lines

Actions	Screen	Comments
<p>Select Data? from the drop down list. Select Input and press  enter key to Continue.</p>		
<p>Key in Point number, Code and Benchmark height. Press  enter key to Store the values. When all points have been entered press  escape key to return to the Editor.</p>		<p>Point number - Select Find to find the next free point number. Code - Select From list to select a code from a list</p>

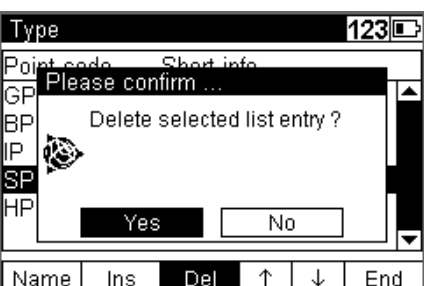
Creating or Modifying the Three Code Lists

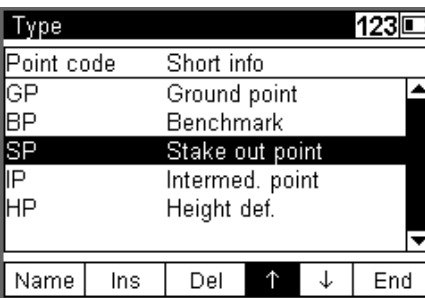
Actions	Screen	Comments
Select a code list from the drop down list press ↓ enter key to confirm.		
Overview about current list content		
To change the name, highlight Name and press ↓ enter key.		
Enter the new name of the code list and press ↓ enter key to Continue.		

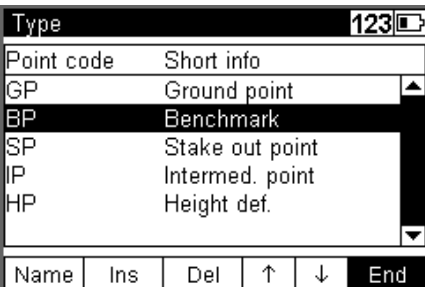
Actions	Screen	Comments
<p>To insert a new item, highlight Ins and press  enter key.</p>		
<p>Select an entry in the list. Highlight Del and press  enter key. Select Yes and press  enter key to continue or select No and press  enter key to abort.</p>		
<p>To change an items order in the list, select the item in the list by pressing the  spider key up or down arrow. When the item is highlighted select the Move Up or Move Down arrow press  enter key to move the item in the list</p>		
<p>Highlight End and press  enter key to confirm all the changes.</p>		

Data Transfer

DiNi to PC

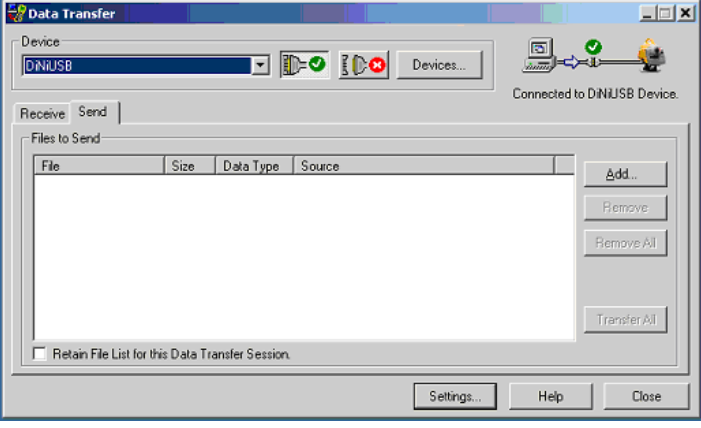
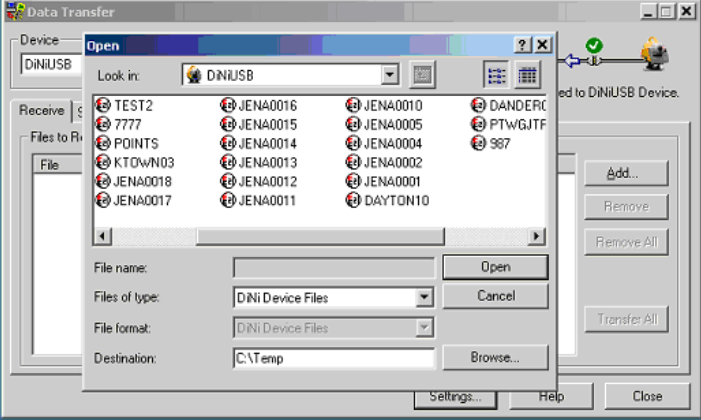
Actions	Screen	Comments
<p>Connect PC via cable PN 73840019 to the Trimble DiNi.</p> <p>Start Trimble Data transfer at the PC</p> <p>Use Device "DiNiUSB"</p>		
<p>Use the "Receive" tab</p> <p>Select the files for transferring to PC</p> <p>Define the folder at the PC and start the data transfer.</p>		



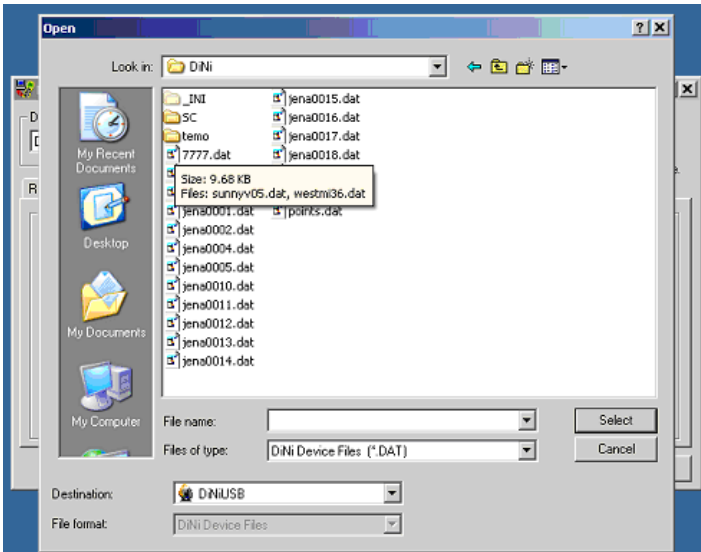



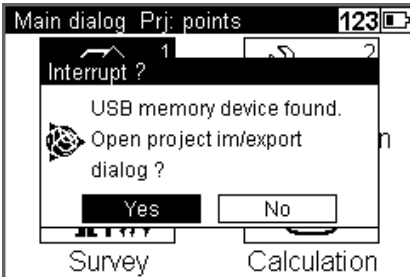
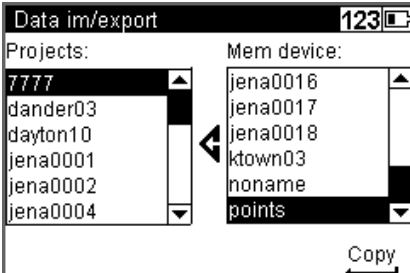

PC to DiNi

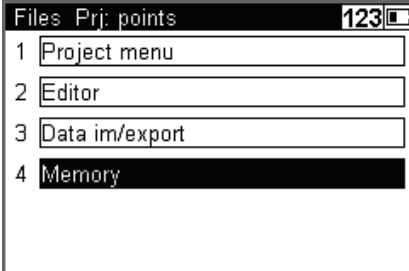
Actions	Screen	Comments
Use the "Send" tab Select the files for transferring to DiNi Start the data transfer.	 <p>The screenshot shows a Windows Explorer window titled "Open" with the address bar set to "DiNi". The left sidebar shows navigation options like "My Recent Documents", "Desktop", "My Documents", and "My Computer". The main pane displays a list of files and folders: "_INI", "SC", "temo", "7777.dat", "jena0001.dat", "jena0002.dat", "jena0004.dat", "jena0005.dat", "jena0010.dat", "jena0011.dat", "jena0012.dat", "jena0013.dat", "jena0014.dat", "jena0015.dat", "jena0016.dat", "jena0017.dat", "jena0018.dat", and "points.dat". A tooltip is visible over "points.dat" showing "Size: 9.68 KB" and "Files: sunnyv05.dat, westm36.dat". At the bottom, the "Files of type" is set to "DiNi Device Files (*.DAT)", the "Destination" is "D:\NiUSB", and the "File format" is "DiNi Device Files".</p>	

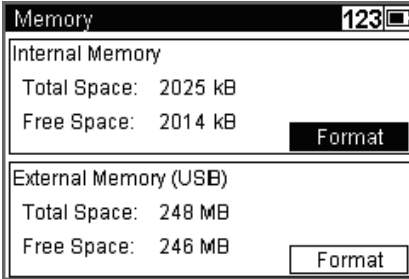
DiNi to USB Memory Stick

Actions	Screen	Comments
<p>Connect the USB Memory Stick via cable PN 73841019 to the Trimble DiNi. The instrument offers the possibility to open the menu for Data import and export directly.</p>		<p>Note – While a measurement runs, the instrument will reject the possibility for this menu! It is possible to open the menu after the measurement via the known workflow.</p>
<p>The instrument allows copying files in both directions.</p>		<p>Note – If the name already exists, the instrument will offer the possibility to copy the file under a new name.</p> <p>Note – Before data transfer the program will check the free space and reject the activity in case of less memory. Please accept unused space for data security.</p> <p>Note – The program will inform and reject an empty file.</p>

Memory

Actions	Screen	Comments
Select Files and Memory	 <p>The screenshot shows a menu titled 'Files Prj: points' with a battery icon and the number '123'. The menu items are: 1 Project menu, 2 Editor, 3 Data im/export, and 4 Memory. The 'Memory' option is highlighted with a black background.</p>	
Select Format Internal Memory or Format External Memory, press  enter key to confirm.	 <p>The screenshot shows the 'Memory' screen with a battery icon and '123'. It is divided into two sections. The top section is 'Internal Memory' with 'Total Space: 2025 kB' and 'Free Space: 2014 kB', and a 'Format' button. The bottom section is 'External Memory (USB)' with 'Total Space: 248 MB' and 'Free Space: 246 MB', and a 'Format' button.</p>	<p>Note – Internal memory and external memory is not comparable. The data are stored in an own compressed format in the instrument. The file size will be internally about 50% of the file size under an Office PC System.</p>
Select Yes and press  enter key to confirm.	 <p>The screenshot shows a warning dialog box with a warning icon. The text reads: 'Warning! Project data will be destroyed. Format internal memory?'. There are 'Yes' and 'No' buttons. The background shows the 'Memory' screen with 'Free Space:' and a 'Format' button.</p>	<p> CAUTION – All data in the internal memory will be erased.</p>
Select Yes and press  enter key to confirm.	 <p>The screenshot shows a warning dialog box with a warning icon. The text reads: 'Warning! Project data will be destroyed. Format external memory?'. There are 'Yes' and 'No' buttons. The background shows the 'Memory' screen with 'Free Space:' and a 'Format' button.</p>	<p> CAUTION – All data in the external memory will be erased.</p>



CAUTION – When formatting the USB Memory Stick and/or internal memory all stored data will be lost.

Data Format

The M5 Data Record Format

All 5 data blocks are preceded by a type identifier. The 3 numerical data blocks have a standard layout comprising 14 digits. In addition to the decimal point and sign, they accept numeric values with the specified number of decimal places. The information block is defined by 27 characters. It is used for point identification (PI) and text information (TI e.g.).

The address block is comprised of 5 digits (from address 1 to 99999).

The M5 Data Line

The data line of the M5 format consists of 121 characters (bytes). The multiplication of this figure by the number of addresses (lines) stored shows the size of the project file in bytes.

Blanks are significant characters in the M5 file and must not be deleted.

The example describes an nine M5 data lines from address 164 to 172. Column 119 includes a blank (no error code).

The end of the line has CR, LF (columns 120 and 121, shown here as <=).

	Column	Description
1	Col. 1-6	Defines M5 format
1	Col. 8-10	Type identifier1 <i>Adr</i> for address
1	Col. 12-16	Memory address of data line
1	Col. 18-20	Type identification2, Trimble DiNi is using TO, KD1 and KD2
1	Col. 22-48	Information block
1	Col. 50-51	Type identifier3 for block3
1	Col. 53-66	Block3 value block
1	Col. 68-71	Unit for block3
1	Col. 73-74	Type identifier4 for block4
1	Col. 76-89	Block4 value block
1	Col. 91-94	Unit for block4
1	Col. 96-97	Type identifier5 for block5
1	Col. 99-112	Block5 value block
1	Col. 114-117	Unit for block5
1	Col. 119	Blank field
1	Col.120-121	Carriage return<, Line feed

Explanation to the data line

Abbreviation	Description	Digits	Characters	Meaning
For	Format identifier M5	3	alpha	DiNi Format
	Format type	2	alpha	5 meas. data blocks
Adr	Address identifier	3	alpha	Value1
	Value1	5	numeric	Memory address
T2	Type identifier	2	alpha	Value2 TO, KDa
a	Marking value	1	numeric	a=1, 2
		27	alpha	Information block
T3	Type identifier	2	alpha	Value3
	Value3	14	numeric	14-digit value
dim3	Unit	4	alpha	4-digit unit
T4	Type identifier	2	alpha	Value4
	Value4	14	numeric	14-digit value
dim4	Unit	4	alpha	4-digit
T5	Type identifier	2	alpha	Value5
	Value5	14	numeric	14-digit value
dim5	Unit	4	alpha	4-digit

Special char.	Description	Digits	ASCII code	Hex code
	Separator	1	ASCII124	Hex 7C
<	CR (Carriage Return)	1	ASCII13	Hex 0D
=	LF (Line Feed)	1	ASCII10	Hex 0A

The Text Information in the M5 Format

The information block has 27 characters.

The Type Identifier in the M5 Format

In the course of the time, requirements on the data format have increased. Therefore, the M5 Format carries most of the type identifiers of all available formats, always based on the preceding format.

Type identifiers are defined by two characters (except for Adr). If only one character is necessary, the second character is a blank.

In the M5 Format there are 5 Type identifiers (TK) defined:

- TK1: Adr Identifier address (Value1)
- TK2: T2 Identifier information (Value2)
- TK3: T3 Identifier 3. Value field (Value3)
- TK4: T4 Identifier 4. Value field (Value4)
- TK5: T5 Identifier 5. Value field (Value5)

Example:

"KD" for point identification, "TO" for text information, "R", "HD", "Z" for T3, T4, T5.

Definition of the Type Identifiers

Type identifiers are assigned to the 5 measuring data blocks of pre-set codes, which show the number or character value of the block.

Type identifiers are (except for Adr) defined with two characters. If only one character is necessary, the second character is blank. The code is case sensitive.

Type Identifiers - Formats M5

TI in Display	TI in Record	Designation
R	R	Single staff reading
Rb	Rb	Staff reading in backsight
Rf	Rf	Staff reading in foresight
Rz	Rz	Staff reading in intermediate sight
sR	sR	Standard dev. of mean staff reading (in multiple meas.)
nM	-	number of measurements (in multiple measurements)
mR	-	nominal standard deviation (in multiple measurements)
Z	Z	Height of backsight point
Z	Z	Height of point measured in foresight
Z	Z	Height of intermediate sight

TI in Display	TI in Record	Designation
Zi	-	Instrument height (equal to sight. h.)
Zs	Z	Nominal height/closing height
h	-	Height difference of a station or height difference from previous measurement
Sh	-	Height difference of complete line
dz	dz	Setting out difference (nominal-actual)
dz	dz	Closing difference of line (nominal-actual)
HD	HD	Single distances
HD	HD	Backsight distance
HD	HD	Foresight distance
HD	HD	Intermediate sight distance
Da	-	Mean value of backsight distance (for display only)
Da	-	Mean value of foresight distance (for display only)
DRI	-	Reading from the lower Reichenbach stadia line
DRu	-	reading from the upper Reichenbach stadia line
Db	Db	Total of backsight distances
Df	Df	Total of foresight distances
c_	c_	Line of sight error
rk	rk	Refraction coefficient
Of	Of	Staff offset
PNo	*	Point number recorded in information block
Code	*	Point Code recorded in information block
Zno	*	Line number recorded in information block
Sno	*	Station number recorded in information block
-	TO	Text information, general
-	KD	Point identification

Note – Values which are neither displayed nor recorded are marked by a dash (-). The Db and Df data refer to the last station completed.

Recording Data and Data Lines With DiNi

Mode	Content of Record							Comments
	Content of PI	R-M			RMR			
		T1	T2	T3	T1	T2	T3	
Single Point meas.	R	HD		R	HD		
Multiple meas.	R	HD	sR	R	HD		
Line	Start-Line BF							
	Start-Line BFFB							
			Z			Z	Reference height
	Cont-Line							after line interrupt.
Line BF	Rb	HD	sR	Rb	HD		Backsight1
	Rf	HD	sR	Rf	HD		Foresight1
						Z	Foresight height
Line BFFB	Rb	HD	sR	Rb	HD		Backsight1
	Rf	HD	sR	Rf	HD		Foresight1
	Rf	HD	sR	Rf	HD		Foresight2
	Rb	HD	sR	Rb	HD		Backsight2
						Z	Foresight height
Line intM	Intermediate sight.							
	Rz	HD	sR	Rz	HD	Z	
	End of interm. sight.							
Line SOut	Stake out							
		dz	Z		dz	Z	Stake out diff., nom. height
	Rz	HD	sR	Rz	HD	Z	Check measurement

Mode	Content of Record							Comments
	Content of PI	R-M			RMR			
		T1	T2	T3	T1	T2	T3	
	End of stake out							
Line end		dz	Z		dz	Z	Nominal closing height
	Db	Df	Z	Db	Df	Z	Actual closing height
	End of line							
Intermediate sights and Stake out	Backsight							
			Z			Z	reference height
	R	HD	sR	R	HD		backsight meas.
Adjustment	refract.ON/OFF earth curv. ON/OFF	c_			c_			appropriate the inputs
	Date Time							
INP	Visual measurement							before input data
Input	Value inputted	rk			rk			
	Value inputted	Lx			Lx			
Comments	Info							enter info
Record instrument status	Measuring unit: meters							Combination of - Measuring units, - Adjustment and - Input
Normal/IN V	Normal rod							after change
	Inverted rod							after change

The recording data line "Optical measurement " refers to the next measurement even if it is not recorded in the following data line.

Adjustment



In this chapter:

- Adjusting the Line of Sight
- Check the Function of Circular Bubble
- Adjustment of Circular Bubble

Adjusting the Line of Sight

The instrument adjustment defines the necessary corrections for the line sight of DiNi, which are required to ensure optimum measuring accuracy. Increased strain placed on the instrument by extreme measuring conditions, transportation, prolonged storage and major changes in temperature may lead to misalignment of the instrument and faulty measurement results, particularly in case of different distances from instrument to staff. Adjusting the line of sight and defined measurement methods eliminating these errors.

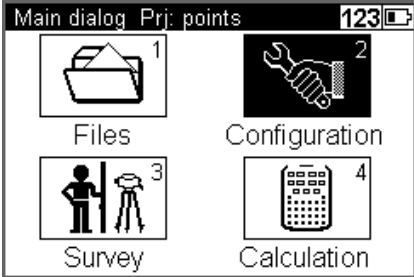
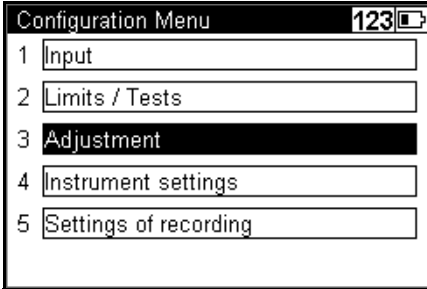
Calling up the Adjustment Function

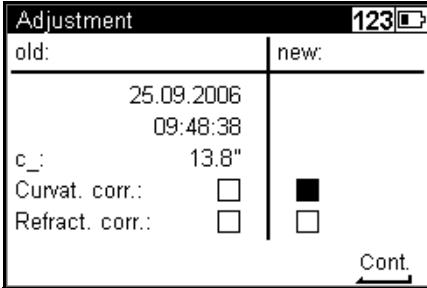
Actions	Screen	Comments
Select Configuration from the Main Dialog		
Select Adjustment from the Configuration menu.		
<p>The old adjustment value and information are displayed.</p> <p>Select Curvature and refraction correction on or off during adjustment.</p> <p>Press  enter to continue</p>		

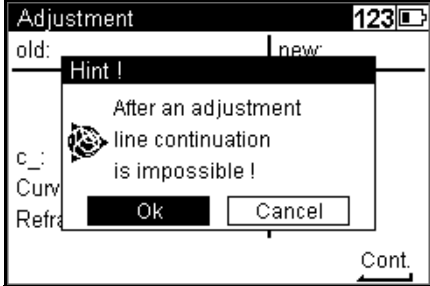
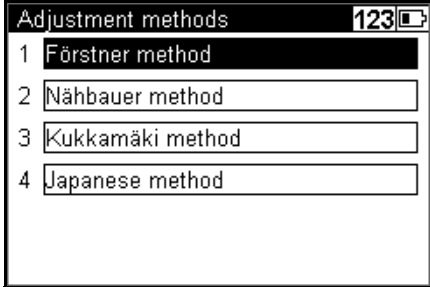
Actions	Screen	Comments
Press Ok to continue or Cancel to abort the adjustment		Note – After an adjustment is made line continuation is impossible.
Select the adjustment method and press \downarrow enter to continue		

Förschner Method

Set up two rods (A,B) roughly 45 m apart. Divide this distance into three and define 2 instrument stations (1,2) about 15 m away from the rods on the connecting line between them. Measure both rods from each of these stations.

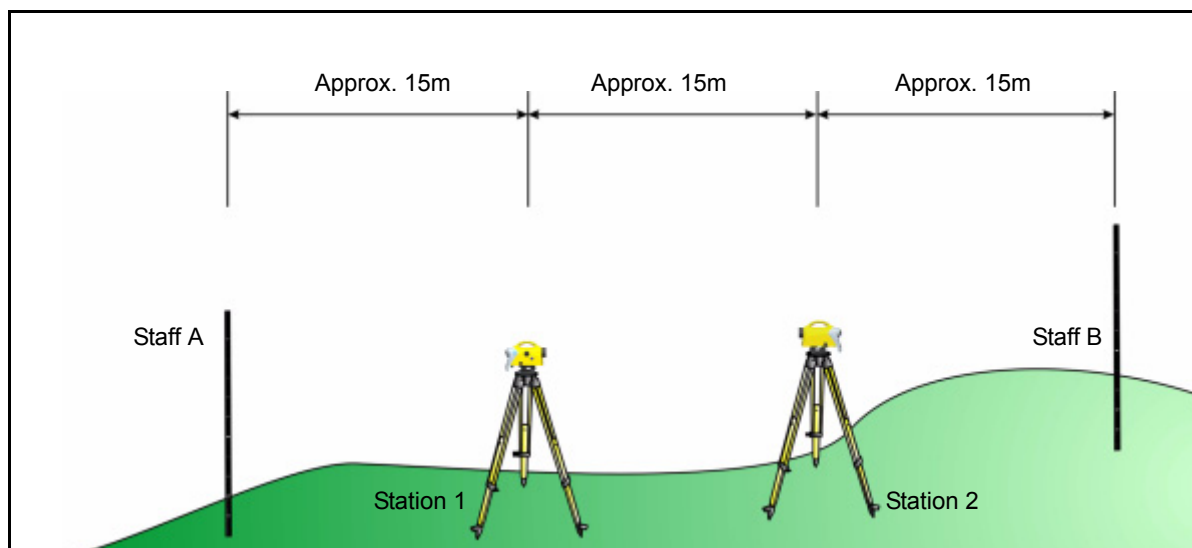

Figure 8.1 Förschner method

Näbauer Method

Define a distance of approx. 45 m length and divide it roughly into three. Create an instrument station (1,2) at either end and set up a staff at each point marking one third of the connecting line (A,B). Measure both rods from each of the instrument stations.

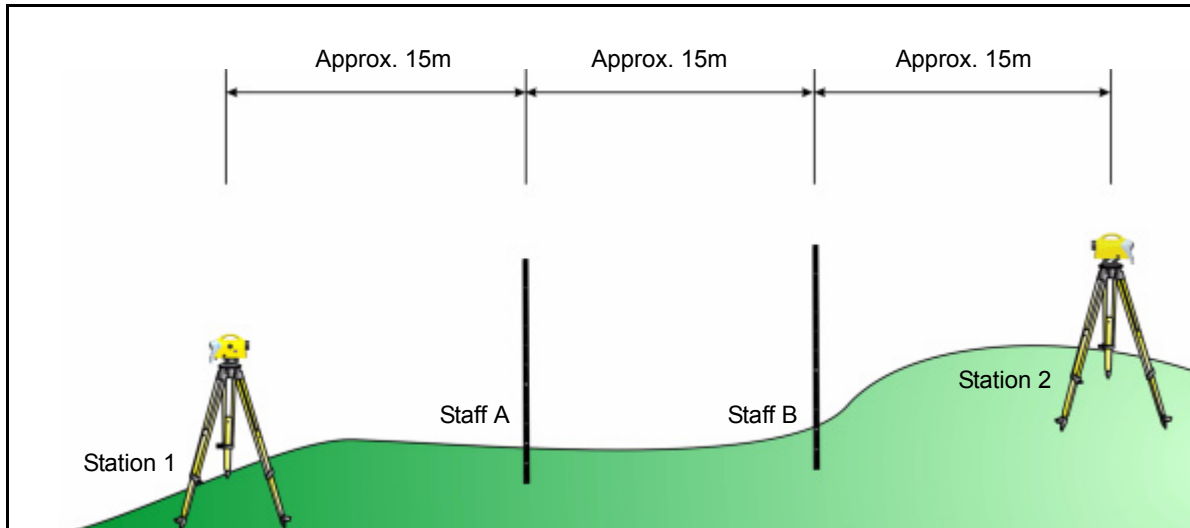

Figure 8.2 Näbauer method

Kukkamäki Method

Set up 2 rods (A, B) roughly 20 m apart. First measure these rods from instrument station (1) located midway on the connecting line between the two rods. Then repeat the measurement from instrument station (2) which is located on the elongation of the two staff stations approx. 20 m outside the defined distance.

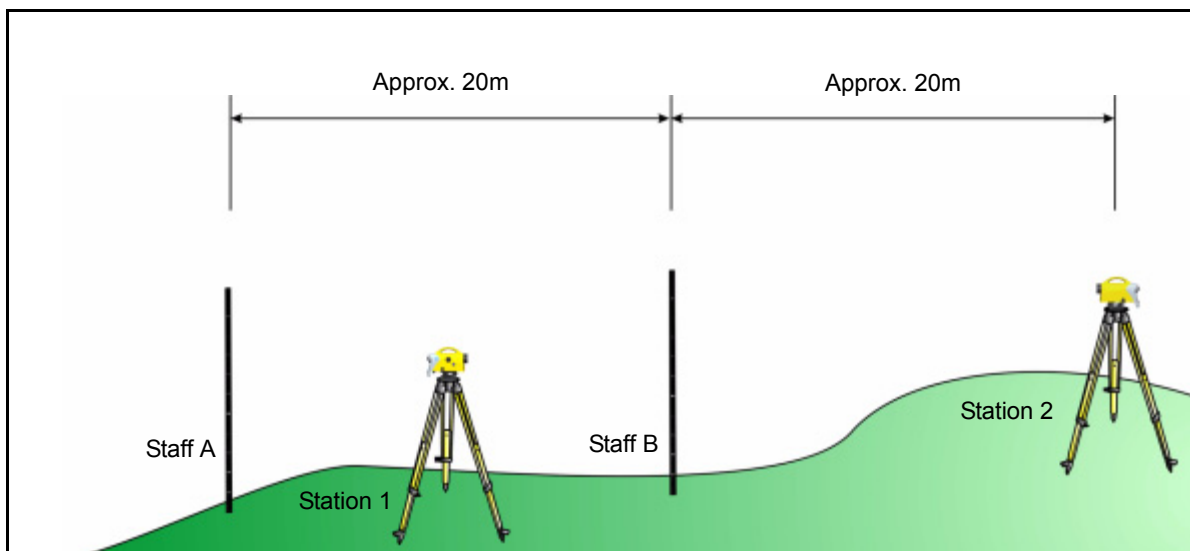

Figure 8.3 Kukkamäki method

Japanese Method

This method is largely identical with the Kukkamäki method. With this method, however, the distance between the rods should be about 30 m with station (2) being about 3 m behind staff A.

Making the Adjustment











CAUTION – Before starting any adjustment, allow the instrument to adapt to the ambient temperature and make sure it is protected against heating up on one side (sun radiation).

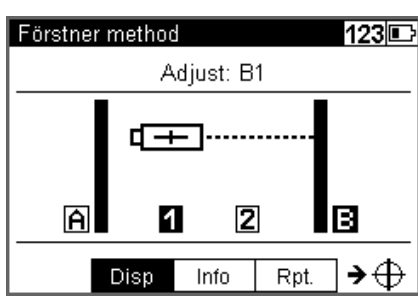

CAUTION – After the selection of the adjustment method, you can change the settings of earth curvature and refraction. This is not possible at another point of the DiNi menu system. Changes of earth curvature and refraction settings become effective only if you adjust the system afterwards. The line of sight will then be corrected accordingly.

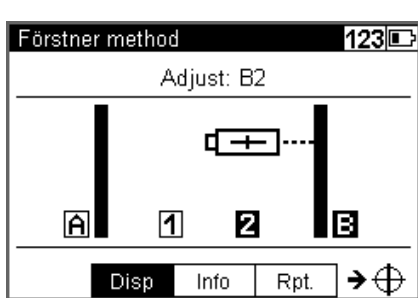
It may become necessary to correct the staff reading for earth curvature, if you must take measurements with different sighting distances and correction is not provided by the evaluation program used. General application of refraction correction is controversial. It is, however, possible on DiNi instruments. You can change the coefficient of refraction in the **Input** menu. If you set the coefficient to zero, the correction of refraction will be inactive.

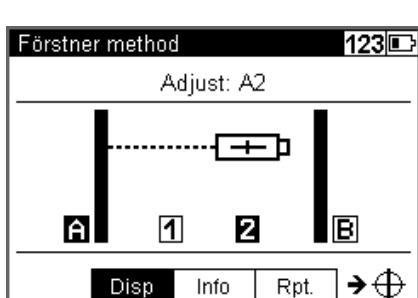
Actions	Screen	Comments
<p>Select the method of your choice.</p> <p>In this example we will show the Förschner method.</p>		
<p>Aim and focus the DiNi at staff A from position 1, press  to measure.</p>		<p> Tip – While the adjustment measurement a multiple measurement should be used.</p>

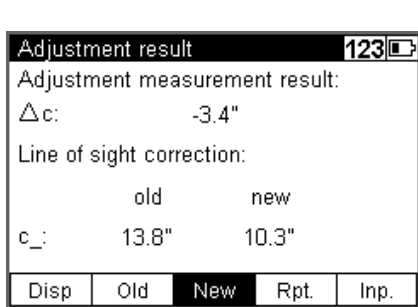
Actions	Screen	Comments
Aim and focus the DiNi at staff B from position 1, press  to measure.		Disp. offers the possibility to show at every step all done measurements.
Aim and focus the DiNi at staff B from position 2, press  to measure.		
Aim and focus the DiNi at staff A from position 2, press  to measure.		
<p>The result of the adjustment will be displayed.</p> <p>To accept the new value select New and confirm with  enter.</p>		<p>Select Inp. to input a value estimated by repetition of measurements</p> <p>Select Old to keep the old values and abort the adjustment.</p> <p>Select Rpt. to repeat the adjustment.</p> <p>Select Disp. to see all measured values.</p>

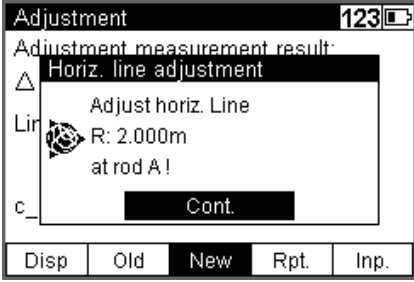
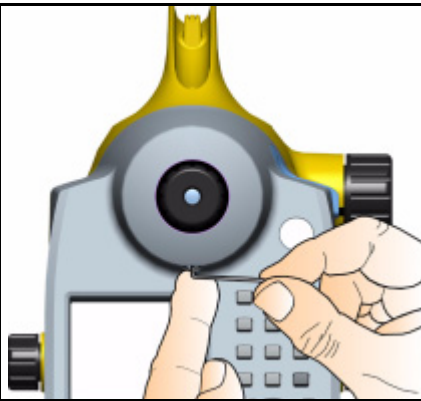
Actions	Screen	Comments
<p>Turn the staff A around or replace it with a metric graduated staff and compare the reading with the specified value R. If the difference exceeds 2 mm, the reticule position needs to be aligned.</p>		
<p>Remove cap and adjust the setting screw below the eyepiece until the actual and nominal readings are identical.</p>		<p>⚠ CAUTION – Make sure that the cap is fixed again after this procedure.</p>

Various adjustments of lines of sight carried out successively should differ only by some seconds. Prerequisites for reaching this result are stability of installation and unchanged environmental conditions. We recommend to prepare a set of chronological statistics including the adjustment values. In case of inexplicable differences within short periods, provided the measuring conditions remained unchanged, a workshop should be consulted.

Example:

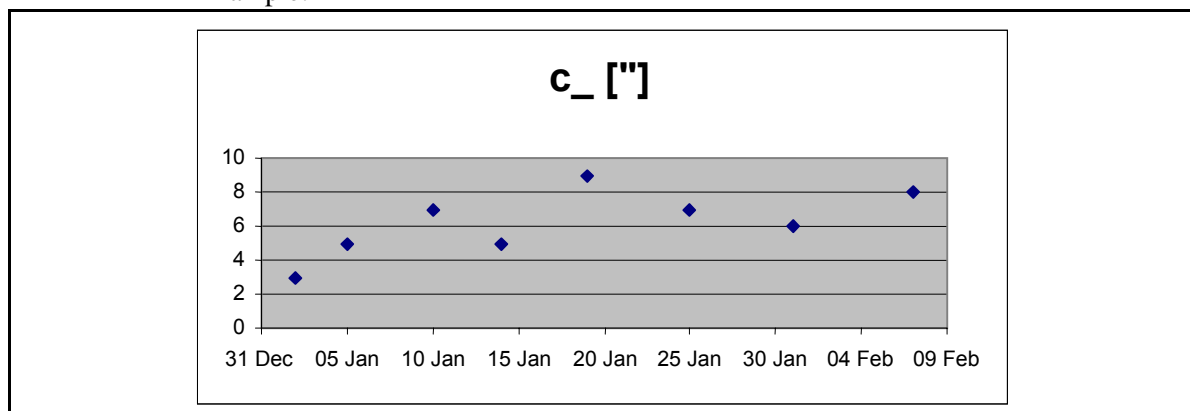

Check the Function of Circular Bubble

Automatic alignment of the compensator ensures that an inclined line of sight is automatically leveled within the working range both for visual observation and internal electronic measurement. When turning the instrument round the vertical axis, the circular bubble has to remain within the adjustment circle.

In precision measurements, the running centre of the circular bubble has to be in the centre of the adjustment circle. In case of any visible change readjustment is required.

1. Level the instrument with the 3 tribrach screws until the circular bubble runs centrally to the adjustment circle.

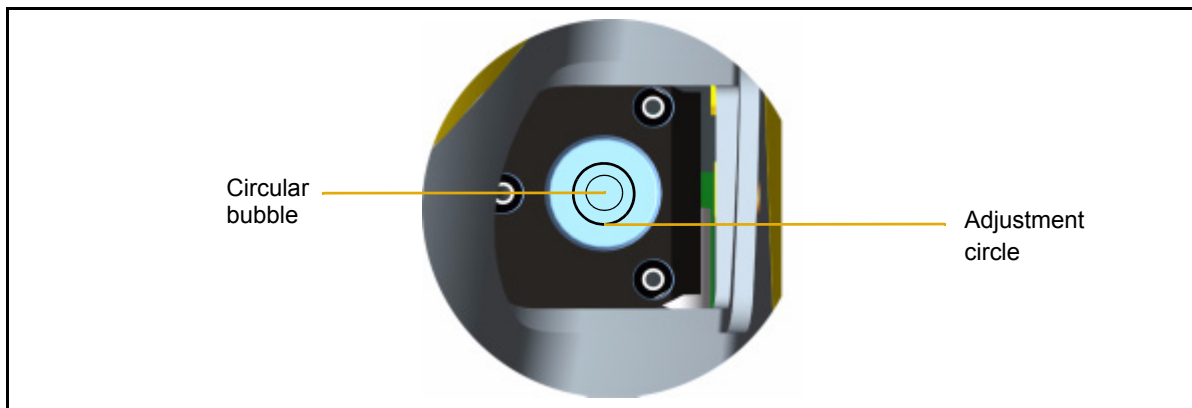

Figure 8.4 Circular bubble check step 1

2. By turning the instrument 180° round the vertical axis the circular bubble has to remain within the circle

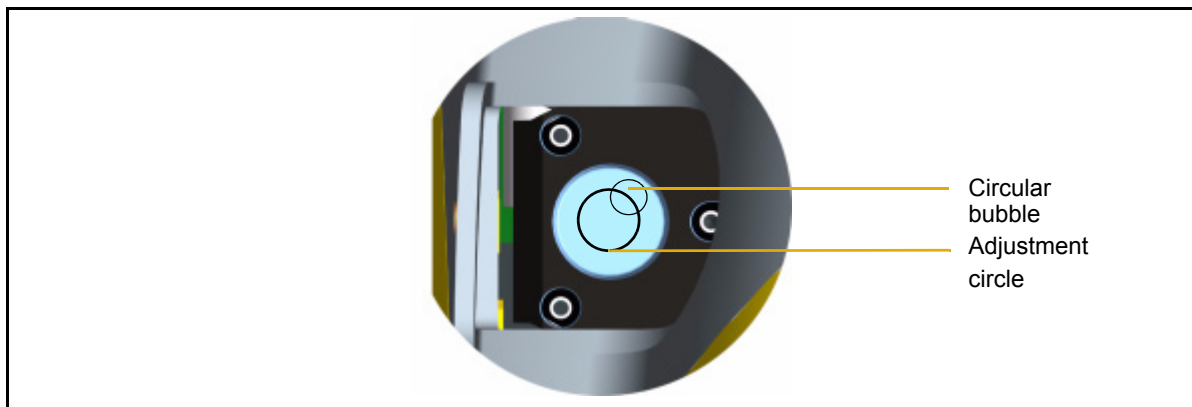

Figure 8.5 Circular bubble check step 2

3. If the circular bubble left the adjustment circle it is necessary to adjust the circular level.

Adjustment of Circular Bubble

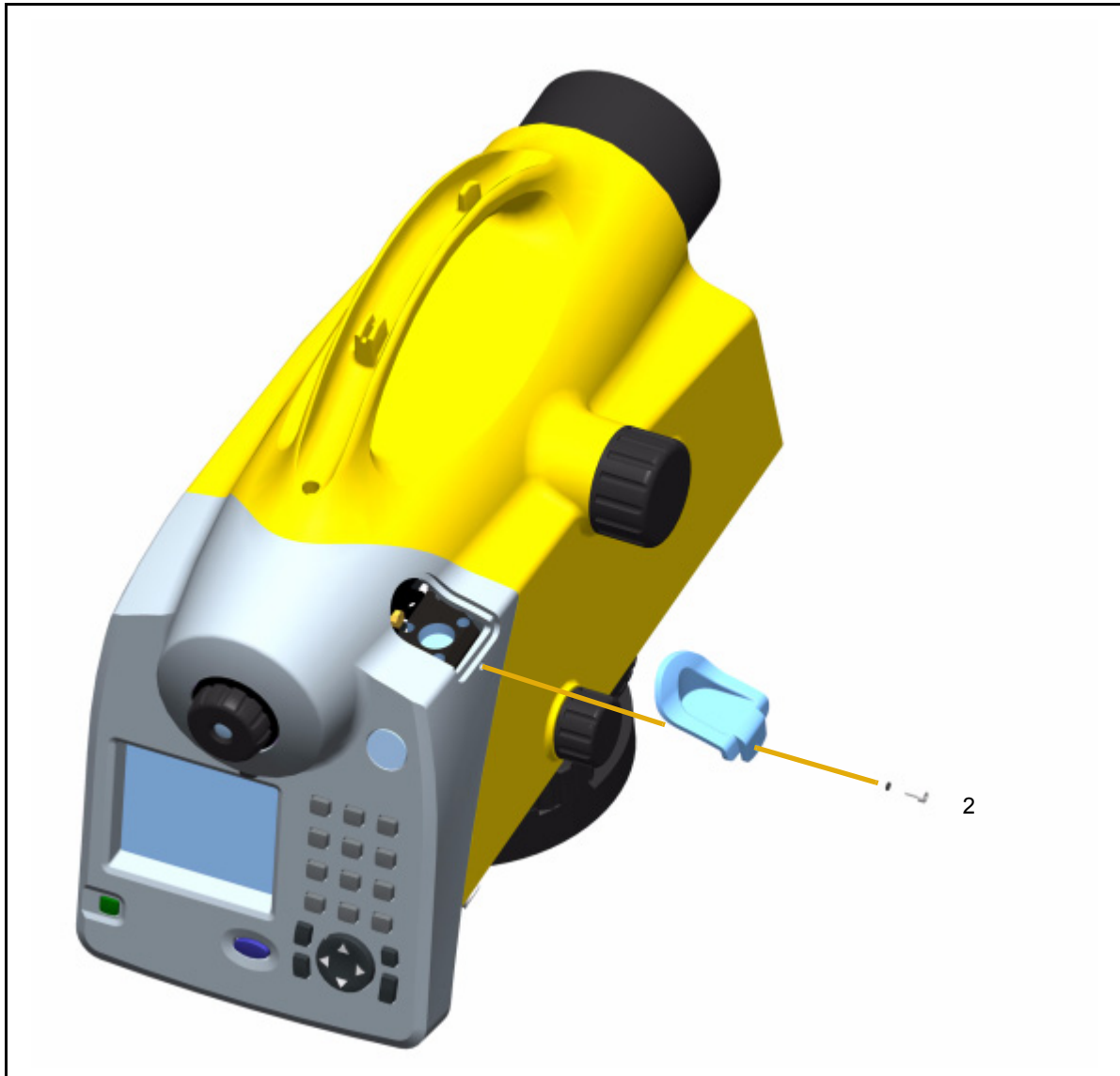

Figure 8.6 Removing the circular bubble protection cap.

Position 1

Figure 8.7 Position 1

1. Remove the screw (2) of the protection cap with the adjusting tool and detach the protection-cap, see Figure 8.6.
2. Level the instrument with the 3 tribrach screws, Position 1.
3. Turn the instrument 180° round the vertical axis into position 2.
4. Eliminate half the residual deviation of the circular bubble by means of the tribrach screw and half by adjusting the circular bubble with the adjustment screws J1, J2, J3.
5. Repeat this procedure and check the residual deviation.
6. Fix the protection cap again. Make sure that the rubber joint is placed in the groove.

Position 2

Figure 8.8 Position 2

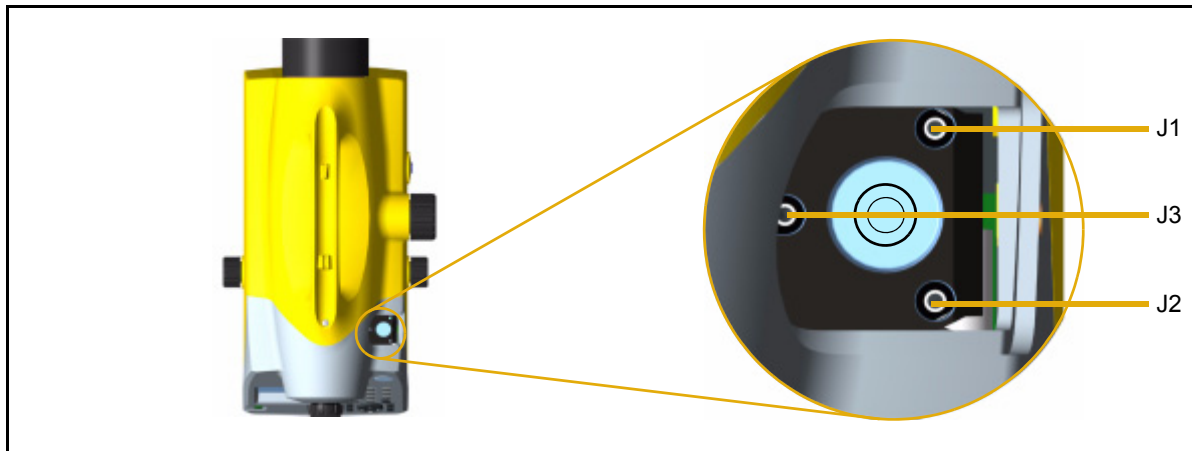
Annex

In this chapter:

- Technical Data
- Formulae and Constants
- Update

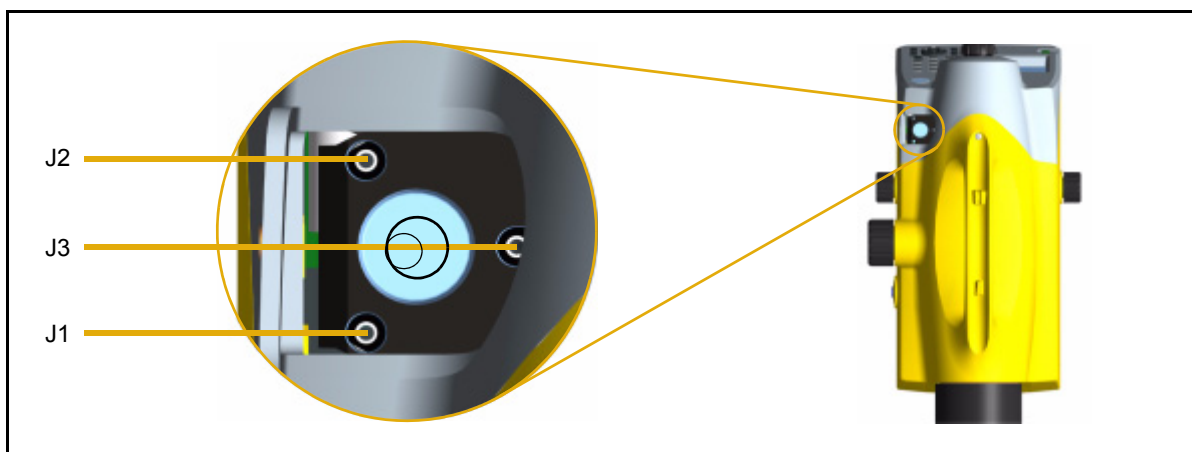
Technical

Technical Data

Technical Data DiNi®	0.3	0.7
Accuracy as per DIN 18723		
Standard deviation on 1 km of double leveling		
Electronic measurement:		
- invar precision bar code staff	0.3 mm	0.7 mm
- foldable bar code staff	1.0 mm	1.3 mm
Visual measurement		
- foldable staff, metric scale	1.5 mm	2.0 mm
Measuring range		
Electronic measurement		
- invar precision bar code staff	1.5 - 100 m	
- foldable bar code staff	1.5 - 100 m	
Visual measurement		
- foldable staff, metric scale	from 1.3 m	
Accuracy of distance measurement		
Electronic measurement with a 20 m sighting distance		
- invar precision bar code staff	20 mm	25 mm
- foldable bar code staff	25 mm	30 mm
Visual measurement:		
- foldable staff, metric scale	0.2 m	0.3 m
Least display unit		
Height measurement	0.01 mm//0.0001 ft/ 0.0001 in	0.1 mm//0.001 ft/0.001 in
Distance measurement	1 mm	10 mm
Measuring time		
Electronic measurement	3 s	2 s
Telescope		
Magnification	32 x	26 x
Aperture		40 mm
Field of view at 100 m		2.2 m
Electronic measurement field at 100 m		0.3 m
Compensator		
Inclination range		± 15'
Setting accuracy	± 0.2"	± 0.5"
leveling		
Circular level		8/2 mm with illumination
Display		
Screen	240(W) x 160(H) pixel ; Black/White ; with illumination	

Technical Data DiNi®	0.3	0.7
Horizontal circle		
Type of graduation	400 grads and 360 deg.	
Graduation interval	1 grad and 1 deg.	
Estimation down to	0.1 grad and 0.1 deg.	
Keyboard		
	19 keys, incl. 1 spider key for navigation	
Measuring programs		
	<ul style="list-style-type: none"> • Single measurement with and without stationing • Staking out • Line leveling with intermediate sight and stake out • Line adjustment 	<ul style="list-style-type: none"> • Single measurement with and without stationing • Staking out • Line leveling with intermediate sight and stake out
Leveling methods		
	BF, BFFB BFBF, BBFF, FBBF aBF, aBFFB, aBFBF, aBBFF, aFBBF	BF, BFFB aBF, aBFFB
Measured data correction		
	Compensation of earth curvature and refraction	
Recording		
Internal memory	up to 30000 data lines	
Data transfer	USB Interface for Data transfer to PC	
External memory	USB Flash drive support	
Real-time clock and temperature sensor		
	Recording of time or temperature	
Power supply		
	Internal battery, Li-Ion 7.4 V 2.4 Ah for three days working time without illumination	
Temperature range		
	-20 °C to +50 °C	
Dust- and waterproofness		
	IP55	
Dimensions (WxHxD)		
Instrument	155 mm x 235 mm x 300 mm	
Case	240 mm x 380 mm x 470 mm	
Weight		
Instrument / case	3.5 kg / 3.7 kg	

Formulae and Constants

Correction of Staff Reading and Sighting Distance

$$L = L_o \pm L_x - K_1 + K_2 - K_3$$

$$K_1 = E^2 / (2 * R) \text{ earth curvature correction}$$

$$K_2 = rk * E^2 / (2 * R) \text{ refraction correction}$$

$$K_3 = c_ * E / 206265'' \text{ line of sight correction}$$

where:

L_o	uncorrected staff reading
E	sighting distance
$c_$	line of sight correction in ["]
L_x	staff offset (+ L_x in normal measurement, - L_x in inverse measurement)
R	earth radius, $R = 6380\ 000$ m
rk	refraction coefficient

$$E = E_o + A$$

where:

E_o	uncorrected sighting distance
A	distance addition constant

Computation of the Line of Sight Correction

$$c_ = ((L_{a2} - L_{b2}) - (L_{a1} - L_{b1})) / ((E_{a2} - E_{b2}) - (E_{a1} - E_{b1})) * 206265 ["]$$

If refraction and/or earth curvature correction are activated prior to adjustment, the staff readings are corrected first (corrections K_1 and/or K_2).

Station Difference in Multiple Back- and Foresights

$$dL = | (L_{b1} - L_{f1}) - (L_{b2} - L_{f2}) |$$

Basis of Calculation for Line Adjustment

Line adjustment is always based on the measured and computed data recorded during leveling line measurement. Before the line adjustment, it is possible, however, that you enter the reference heights (start/end), if they had not been known in the measurement.

The heights of staff stations in line leveling and those of intermediate sights are modified proportionally to the passed distance as follows. For station n, the following equations apply:

Foresight:

$$E_n = E_{n-1} + E_b + E_f \quad Z_f = Z_{fu} + \frac{E_n \cdot \Delta Z}{S_b + S_f}$$

Intermediate sight:

$$E_n = E_{n-1} + E_b + E_i \quad Z_i = Z_{iu} + \frac{E_n \cdot \Delta Z}{S_b + S_f}$$

n	Number of station
E	Sighting distance
E _b	Backsight distance
E _f	Foresight distance
E _z	Intermediate sight distance
S _B	Total of all backsight distances of the line
S _f	Total of all foresight distances of the line
ΔZ	Line closing difference
Z _{fu}	Uncorrected height of foresight
Z _{iu}	Uncorrected height of intermediate sight

In the project, the values of Z_{fu} or Z_{iu} are overwritten by Z_f or Z_i.

Update

Furnishing of Updates

Software updates are offered by the manufacturer on Internet sites with reservation as to extensions of the functional range. Surf to our Web sites. The dealer will be pleased to communicate the Internet site names, when required.

Link for SW updates

http://www.trimble.com/dini_ts.asp

The updates offered contain the following functions:

- Update of the instrument computer
- Loading of an additional language (three languages can be loaded, one language is English)

The files loaded from the Internet sites have to be unpacked and copied to a folder. Please follow the instructions.

Index

A

- area leveling 98
- Australia
 - notices to users ii

B

- battery
 - capacity 14
 - charging 13
 - compartment 19
 - connecting 16
 - disposing of 12
 - low 15
 - removing 16
 - safety 12
 - status 24
- Battery charger 7
 - instrument case 7
- battery charger
 - description 13
 - LEDs 13
 - power supply 7

C

- Cable
 - data transfer 100
 - in instrument case 7
 - USB Memory Stick cable 119
- care and maintenance 8
- Circular bubble
 - description 136
- cleaning 8
- code
 - entering 64
 - Staff code 94
- code lists
 - creating 115
 - modifying 115
- Communication
 - connector 18

D

- data lines
 - deleting 110–113
- Date and Time 39
- Declaration of Conformity vii
- display contrast 56

E

- environmental information
 - European Union iv
- Europe
 - notices to users ii
- European Council Directive 89/336/EEC ii

F

- focusing
 - knob 18
 - telescope 37

I

- intermediate sights 21, 47, 68, 74, 80
- inverted staff 25, 50

K

- keys 22

L

- limits 21, 40
- Line adjustment
 - calculation 142
- line adjustment 68, 88
- Line leveling 21
- line leveling 32, 40, 46, 47, 63, 68, 74, 75, 76, 88
- line of sight
 - adjustment 130
 - correction 142
 - inclination 30
- line of sight correction 142

M

measurements
 multiple 51
 repeated 51, 60, 73
measuring time 95, 140

N

New Zealand
 notices to users ii
notices to users
 Australia and New Zealand ii
 Europe ii

P

packing for Transport 9
precision measurement hints 34

R

reticle 18

S

safety
 battery iii–iv, 12
Servicing 9
settings
 of recording 44
single point measurement 21, 66
Sound
 On/Off 43
stake out 21
 call up stake out point 46
 digital staff 86
 in line leveling 75
support 2
symbo
 measurement 25
symbol
 battery capacity 14
 compensator out of range 30
 illumination 55
 inverted staff 25

T

technical data 140
technical support 2
temperature 133
 ambient 35, 97, 98, 130, 133
 battery charger 13
 sensor 97
time
 battery charging 14
 working time 14
time input 39, 53

U

unit 42, 43, 100, 140